

Air gaging innovative products and solutions



The Millimar product family offers state-of-the-art metrology: modular, precise, flexible and user-friendly, perfect for modern and quality-conscious manufacturing.

Experience with gaging technology

Technical innovation and quality-oriented thinking are the core competencies of successful businesses. Both competencies are not possible without metrology. Measurement instruments verify research and development results and document product quality. Without continuous advancement of metrology, there would be no technical progress

Mahr has been an innovator of precision hole gaging since the first air gaging was introduced in the 1940's. Mahr has perfected the single master air gage system that out performs other systems with its accuracy and linearity. The quality is built into the air tooling, display units and the precision masters.

Over this period of time, Mahr has designed 100,000's of air gages - from the most basic air plug to complex automated air gaging systems. All are capable of measuring the most demanding manufactured pieces - critical for today's automotive, medical and aerospace requirements.

Recently, Mahr has further advanced its leadership with a new line of Millimar display systems and modular gaging components that allow for unmatched performance in fixed magnification or from adjustable magnification air gaging systems. Our breakthrough products bring ease of

use and high performance to any air gaging system.

Mahr has invested in new manufacturing processes with parametric programming, allowing for reduced delivery times for air tooling. Also, new high tech coatings have been employed to ensure long lasting tooling even under the harshest manufacturing conditions.

Engineering solutions to these tough measuring application demands is done all within the Mahr Group. From the initial concept, through engineering, design, precision manufacturing and finally assembly and test, all stages are performed in house. We take full responsibility and accountability for the gages produced - right until they are delivered and performing on your shop floor.

To be a metrology supplier - one has to know and understand metrology. Mahr not only builds the precision into its air tooling and display, Mahr also manufactures most of its own master rings, discs and plugs used as setting standards for the air tooling. Mahr has built one of the best manufacturing and precision measurement facilities in the country. Mahr calibration system is certified to ISO-9001:2015 by NQA, USA and accredited to ISO 17025 NVLAP Lab Code 200605-0.

We are committed to bringing you the best metrology solutions.



Millimar C 1202 does differential air gage application - orthopedic tapers.

Table of Contents

About Us	4
Air Gaging Applications	8
Products	14
Software	24
Air Tooling	28
Air Plugs	29
Measuring Deep Holes	30
Air Snaps	33
Air Rings	34
Jet Probes	35
Accessories	36
Standards	38
Air Gaging Solutions	42
Measurement Center	51
Calibration Services	52
Worksheets	53

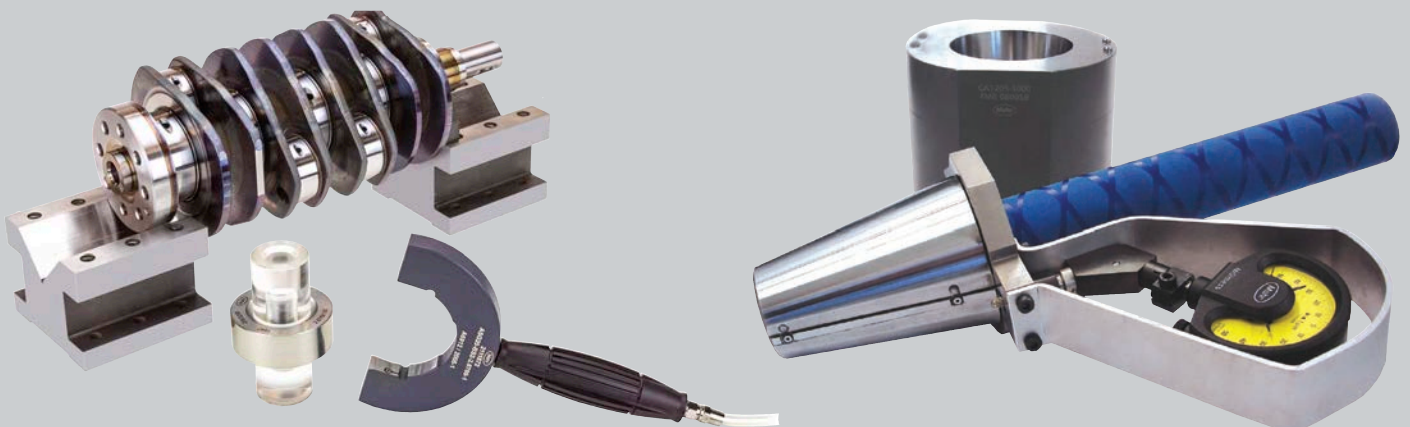

Why Mahr's **air gaging**?

Mahr has been an innovator in air gaging since its introduction in the 1940's. With the Dimensionair tooling system and Millimar readouts, the accuracy is built into both the tooling and readout. This allows for full interchangeability between like systems and ensures total system performance. With the new Millimar display systems and modules precision magnification adjustments allow for the most linear two master systems available.

Experience

Over this period of time, Mahr has designed 100,000's of air gages - from the most basic air plug to complex automated air gaging systems. All are capable of measuring the most demanding manufactured pieces - critical for today's automotive, medical and aerospace requirements.

Innovation

Mahr Inc. offers a wide range of display and tooling options. Offering basic and proven performance along with some of the most progressive portable gaging systems brings precision to the shop floor. New materials for air tooling such stainless steel and AlChrNi diamond like coatings are some of the options for manufacturing tooling that meets the requirements of your specific application.

Delivery performance

Ordering tooling and not having it when you need it just does not work. Mahr has put in place manufacturing principles, high speed automated systems with parametric programming that can get you the tools you want when you need them. We deliver on time, to customer's expectations and demonstrate it time after time. Many fractional size tools are even kept in our depot to help fulfill critical needs.

Value and service

Mahr offers one of the largest trained sales teams to offer expertise to solve your measurement problems. A team of Direct Field Sales personnel, Providence-based Application Engineers and Factory Trained Distribution is available to support you both before and after the sale. Combining this with new processes that actually allow for more cost effective tooling helps to provide the best value for your measurement solution.



Stand alone air gaging for bore diameter



Complete turn key gaging station with operator guided sequence of part measurement, classification and documentation.

The need for **air gaging**

Air gaging is the inspection tool that allows you to measure many jobs faster, more conveniently, and more accurately than other gaging methods. In the measurement of all hole conditions, air gaging is unsurpassed for speed and accuracy. Similarly while in checking many other dimensional and form characteristics, air offers sufficient magnification and reliability to measure tolerances well beyond the scope of mechanical gages. As tolerances keep getting smaller air gaging at the point of manufacture is more important than ever.

Easy to use

Production workers do not require special training to use air gages. To check a hole, for instance, it is not necessary to develop skill in rocking the gage to find the true diameter, merely insert the air plug in the hole and read the meter. It is as simple as that. With it made for the part characteristic and differential measurement, the part is measured with no operator influence.

Economical

Once the basic gage is purchased, additional tooling for a wide variety of jobs can be used with it. It is not necessary to buy a complete gage for each new dimension that requires checking. All Mahr air tooling is manufactured to the same high standards allowing for interchangeability and assured performance. Because of its adaptability, air gaging often becomes the primary measuring system in a complete quality control program.

Versatile

Air gages effectively measure all common types of dimensions and are particularly suited to checking dimensional relationships. Some of these are taper, parallelism, squareness, straightness, and center distance. Match gaging, which permits the selection of mating parts for a specific amount of clearance or interference, is easily accomplished with just one measurement providing not only both diameters of the match but also the match clearance

The non-contact characteristic of air gaging makes it particularly useful for checking soft, highly polished, thin-walled or otherwise delicate material.

Small gaging jets and powerful display units give air gages a distinct advantage in measuring multiple dimensions. Fixtures are smaller and remote meters permit placing contacts in positions that are inaccessible for other types of gages. Air gaging is combined with electronic signaling to provide instant indication of part size and classification.

Air gages are readily adaptable to measuring parts in the machine. Their small gage heads make most dimensions accessible with new displays that can bring the measurement results right to the point of manufacture, thus speeding the process and making it easier for the operator to make critical measurements. A unique advantage is that the stream of air tends to clean the measuring area from coolant or oil, providing accurate measurement without first cleaning the part.



The non-contact characteristic of air gaging makes it particularly useful for checking soft, highly polished, thin-walled or otherwise delicate material.



Small jets give air tooling a powerful advantage in measuring multiple dimensions simultaneously.

What is air gaging and why does it work?

Air gaging is a measuring system that uses air pressure to determine the size of a measured part. With the laws of physics to make the measurement, the system relies on the fact that pressure is directly proportionate to clearance.

The relationship between air pressure and distance of a restriction (workpiece) to the air escape (jets) can be plotted on a graph (line a). As the distance between jets and work surface increases, the pressure decreases and the ratio becomes linear, as represented by the straight section b.

This straight portion of the curve can be accurately calibrated, and represents the deviation shown on the display unit. Compare its length with c on the other curve, which is the usable portion of other air gage scales. This longer linear scale gives Millimar its longer usable measuring range. Note also that the Millimar scale is displaced further to the right, providing more initial clearance between the air plug and workpiece surface for easier gaging.

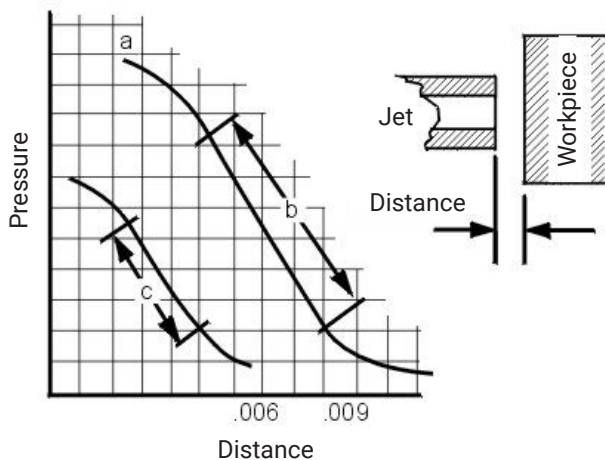

Millimar air gages

Mahr's Millimar air gages are a very linear differential air pressure type and provide the advantages of fixed magnification and a balanced air system. This offers additional advantages of greater tooling clearance for increased wear life, setting to "Zero" with only a single master, and immunity to normal air pressure fluctuations. With Mahr's differential system, the accuracy is built into the tooling and the display.

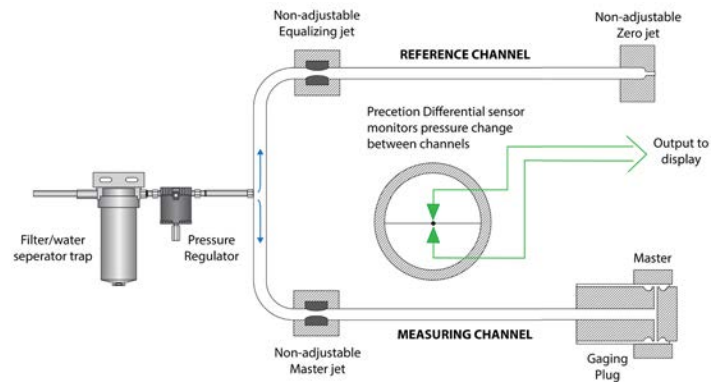

How the balanced air system works

With the balanced air system, air from the supply line first passes through a regulator, then is divided into two channels. Air in one leg (the reference channel) escapes into the atmosphere through the zero restrictor, while air in the opposite leg (the measuring channel) escapes through the gage head jets. The two channels are bridged by an extremely precise pressure sensor indicating meter which responds immediately to any differential in air pressure between the two channels.

Zero setting simple and stable

With the Millimar balanced system, setting zero is entirely independent of the measuring and magnifying functions of the gage. Magnification is fixed and cannot be affected by the setup process.

To set up the gage, a master is placed on the measuring head (producing a back pressure). All Millimar products incorporate a simple zeroing function that automatically sets the display to either zero or the nominal value if selected. Master deviation can also become part of the zeroing process. From then on, any deviation in the size of the workpiece from the master size will change the pressure in the measuring leg and produce a change in displayed reading.

Advances in adjustable (2 master) air systems

Mahr has taken the adjustable magnification back pressure system and adapted it for use with its precision differential air/electronic transducers. Two setting masters - minimum and maximum - are used to calibrate the system, defining and displaying both ends of the particular tolerance range. With modern electronic systems, this process can be automated so that the gage leads the operator through the mastering routine. The zeroing and magnification adjustments are done automatically - without operator intervention. This system is capable of the broad magnification adjustment of any air gage system. It accommodates almost any size nozzle, as large as 0.050 in or as small as 0.020 in.

Advantages of Mahr long gaging range, single master system

The long measuring range of the Millimar Dimensionair system permits a smaller bodied air plug, which provides greater plug clearance. Even with greater clearance, there is no centralizing error. The total clearance between plug body and setting ring is detailed in the table below.

Tool ID	Nominal Size Above	To and Include	Clearance From Nominal Size
60	3.0 mm / 0.118 in	3.6 mm / 0.14 in	0.030 mm / 0.0012 in
	3.6 mm / 0.14 in	4.7 mm / 0.185 in	0.046 mm / 0.0018 in
	4.7 mm / 0.185 in	6.0 mm / 0.236 in	0.061 mm / 0.0024 in
	6.0 mm / 0.236 in	59.9 mm / 2.36 in	0.081 mm / 0.0032 in
	59.9 mm / 2.36 in	74.9 mm / 2.95 in	0.081 mm / 0.0032 in
50	74.9 mm / 2.95 in	127 mm / 5 in	0.089 mm / 0.0035 in
	Above 127 mm / 5 in		0.107 mm / 0.0042 in
	3.0 mm / 0.118 in	3.6 mm / 0.14 in	0.020 mm / 0.0008 in
	3.6 mm / 0.14 in	4.7 mm / 0.185 in	0.028 mm / 0.0011 in
	4.7 mm / 0.185 in	6.0 mm / 0.236 in	0.033 mm / 0.0013 in
20	6.0 mm / 0.236 in	59.9 mm / 2.36 in	0.056 mm / 0.0022 in
	59.9 mm / 2.36 in	74.9 mm / 2.95 in	0.071 mm / 0.0028 in
	74.9 mm / 2.95 in	127 mm / 5 in	0.071 mm / 0.0028 in
	Above 127 mm / 5 in		0.081 mm / 0.0032 in
	3.0 mm / 0.118 in	3.6 mm / 0.140 in	0.015 mm / 0.0006 in
10	3.6 mm / 0.14 in	4.7 mm / 0.185 in	0.018 mm / 0.0007 in
	4.7 mm / 0.185 in	6.0 mm / 0.236 in	0.020 mm / 0.0008 in
	6.0 mm / 0.236 in	59.9 mm / 2.36 in	0.033 mm / 0.0013 in
	59.9 mm / 2.36 in	74.9 mm / 2.95 in	0.071 mm / 0.0028 in
	74.9 mm / 2.95 in	127 mm / 5 in	0.071 mm / 0.0028 in
5	1.57 mm / 0.062 in	44.4 mm / 1.75 in	0.009 mm / .00035 in
	Above 44.4 mm / 1.75 in		0.014 mm / .00055 in
5	For all sizes up to 25.4 mm / 1 in		0.005 mm / 0.0002 in

Type	Measuring Range	Magnification
50	76 µm / 0.003 in	2500:1
20	38 µm / 0.0015 in	5000:1
10	15 µm / 0.0006 in	10.000:1

For applications greater than 1000 feet, special calibration is required.

This economical feature is the result of fixed magnification where the accuracy is built into each display and tool. Because its magnification cannot be adjusted or changed accidentally, or drift because of airline surges, the Millimar display is a linear and calibrated system with known magnification. It's easy to set zero any Millimar display:

- Step one - place the master on air tooling.
- Step two - press the auto zero on the display
- That's all - setup is completed in just a few seconds

Stability - once set, stays set

An outstanding feature of the Millimar system is its stability. Once set, zero does not drift. Because the air pressure in the balanced system is split between two channels, any normal changes in pressure from the regulator or larger surges in the factory air system affect each channel equally and thus cancel out. Therefore, the gage setting is not affected. The only change in measuring pressure is through the variation of workpiece size.

Dependability

Fixed magnification and built-in precision, which is never disturbed by searching for zero or by changes in source pressure, and the stability of its zero setting are why Millimar is so dependable. Tolerance limits never shift during the working day, remaining the same for the last piece as for the first.

Millimar is the gaging of choice in automatic machine control where a lack of reliability in the gaging process can upset an entire production schedule.

Advances for two master systems

Mahr has taken the adjustable magnification system to new limits. For those applications where min-max mastering systems have been incorporated, the flexibility of the two mastering electronic amplifiers provide new read out capabilities. The Millimar display can act as a single master setup with all its advantages - or can be adapted to virtually any existing dual master air tooling. Therefore, it is not necessary to switch air gaging systems - just choose the adaptability of a Mahr Millimar display and put your system to use.

Direct benefits of greater clearance

More versatile gaging - Dimensionair plugs easily enter irregular holes to check conditions such as taper, out-of-round, barrel shape, etc. that are inaccessible to plugs with less clearance.

Increased gaging speed - Quicker entrance into the hole and no jet positioning problem makes gaging faster with Dimensionair plugs than with plugs which require less clearance.

Less plug wear - Greater clearance eliminates much of the wear caused by the plug body rubbing on the edge and walls of the hole. If, after long hard use, a Dimensionair plug should wear, there is no effect on magnification, as frequently occurs with air gages that do not use fixed magnification.

Large, deep-set air jets - Longer range permits the measuring jets to be set deep into the plug body, providing good protection. Dimensionair jets are larger and less likely to become clogged.

One master system

The Millimar system is known as the one master air gage because only one zero master is required for each size to be measured.

Air gaging **applications**

Though most frequently used for diameter measurement, many other types of dimensional conditions can be checked more conveniently, more accurately, and more economically with the Dimensionair than with other types of gages. Though it would be impossible to show every type of measurement successfully accomplished by air, here are a few representative examples.

Configurations for air gaging

1. Thickness or wall thickness measurement with jet air probe.
2. Diameter measurement of cylindrical through bores with air plug gage.
3. Diameter measurement of cylindrical blind bores with air plug gage.
4. Diameter measurement at a given distance from the face of a part. Most plugs can be supplied with a stop collar.
5. Diameter or thickness measurement with air snap gage.
6. Diameter measurement of cylindrical shafts with air ring gage.
7. Straightness measurement of a cylindrical bore with special air plug gage.
8. Match measurement between bore and shaft with air plug gage and air ring gage.
9. Taper measurement of an inner cone with taper air plug gage. Measurement based on differential measurement method.
10. Perpendicularity measurement of a cylindrical bore to the end face with special air plug gage. Measurement based on differential measurement method.
11. Measurement of spacing between separate cylindrical bores with air plug gages. Measurement based on differential measurement method.
12. Measurement of spacing between incomplete cylindrical bores with air plug gages. Measurement based on differential measurement method.
13. Taper measurement, form measurement and diameter measurement of inner cone with taper air plug gage.
14. Multiple internal and external measurements with measuring jets and contact gages in conjunction with a seven-column gage.
15. Multi-jet air plugs can be provided. Jet placement determines the information read by the amplifier.

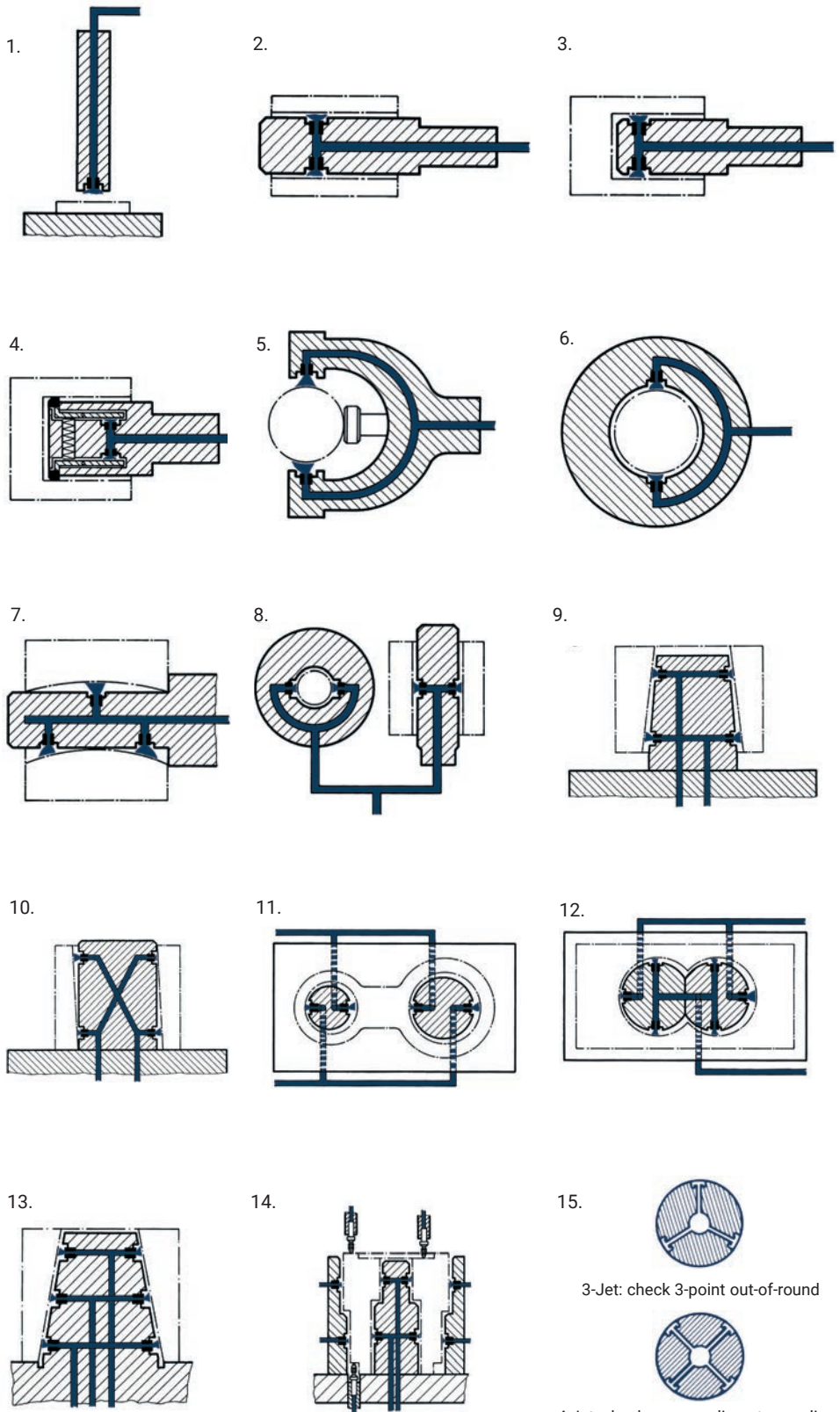

3-Jet: check 3-point out-of-round

4-Jet: check average diameter readings which requires special amplifier

Range of applications

Though most frequently used for diameter measurement, many other types of dimensional conditions can be checked more conveniently, more accurately, and more economically with Millimar air gaging than with other types of gages. The balanced system of Millimar air gaging and the ability to combine two or more air circuits offers unique advantages in gaging certain dimensional conditions such as concentricity, squareness, or straightness.



Clearance and interface (match gaging)

The balanced calibrated system of Millimar permits reading clearance or interference of mating parts, as well as the actual diameter of each part, on one display without any adjustment or resetting.

Millimar display can be used with existing Mahr air match systems to provide clearance results or can be upgraded to not only provide clearance but also actual diameters of both components.

For existing systems where the air plug and ring are connected through "T" fitting to the measuring display, a C 1202 with 4J modules can duplicate the setup. One part (serving as reference) is placed in gaging position and various mating pieces checked in turn until proper clearance reading (left of zero) is obtained. Readings to right of dial indicate interference. Diameter of either part can be sized directly by comparing against master of mating part.

A C 1202 and two air modules provide the ability to update the existing system or with new systems to provide not only the clearance or match fit, but also see at the same time the actual diameters of both parts. Here a clearance would be represented as any plus value resulting from the combination of ID and OD.

With the capability of Dimensionair tooling and Millimar displays, the system can be configured to determine match clearance or match tolerance, either radial or diametrical clearance and used to match by sorting or match by machining the ID to the OD or the OD to the ID.

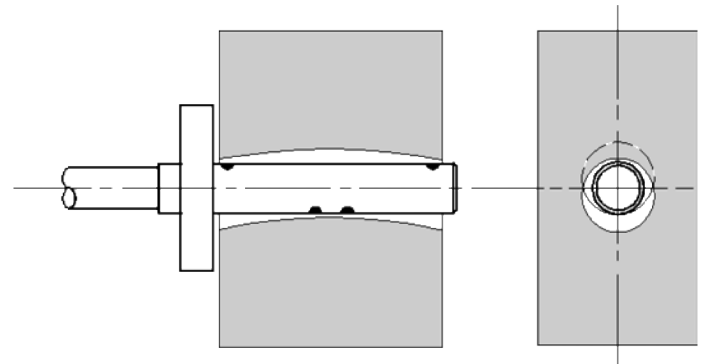

Straightness

Dimensionair air plugs can be used to check straightness of either inside or outside surfaces. A second circuit can also be added to measure diameter at the same time if required. For internal measurement, an air plug is furnished with a set of four jets arranged as shown in the diagram for inspecting straightness. As the plug is rotated 180° any lack of straightness is clearly displayed. A C 1202 with 4J air module used in the dynamic mode would capture the straightness deviation. If the plug also incorporated a diameter circuit a C1202 with a 4J and 2J module can capture diameter variation and straightness simultaneously. An air ring can be similarly equipped for OD measurements.



Center distance

Center distance between bores is checked without influence from piece to piece variation in size on a differential Millimar. Two dual jet air plugs are used as a pair, with the two "near" jets channeled together as are the two "far" jets. Spacing of air plugs in the fixture is set to show the ideal condition, so the display reads zero with a master or nominal workpiece in place. With this arrangement, any change in diameter will affect each pair of jets equally so that center distance checks will be independent of hole diameter. The same type of arrangement using air rings serves center distance of OD's. In each case, only one Dimensionair is required at considerable cost savings over competitive makes.

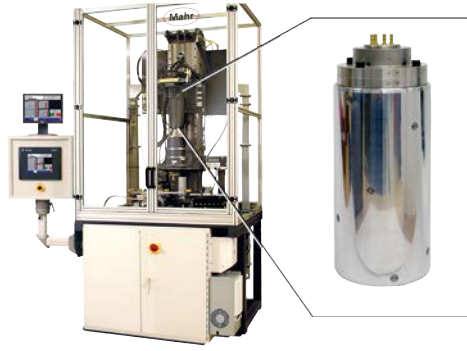

Automatic gaging applications

Special tooling can be designed and manufactured for use in automatic gaging systems. Plugs with multiple jets and circuits can be configured for virtually any size and geometric condition.

Diameter, taper, straightness, concentricity and center location can be checked quickly and accurately with an engineered air plug. Because air jets can be machined into locations where electronic probes would not fit, they provide unmatched gaging capabilities. When the parts are rotated, dynamic checks such as out of roundness and max or min diameters can be found.

In addition, special tooling lead-ins, special wear strips, exotic coatings and floating tooling adaptors can be designed into the automatic gaging station. All these to provide long life of the plug as required for high volume, high production gaging applications.



Flatness, parallelism, thickness

When small parts are involved, either contact or non-contact measurement can be made using a jet probe set in a small surface plate. Since the surface plate acts as a datum, the inspection of the part is made by simply moving it over the probe and the dynamic total indicator reading from Millimar provides total flatness variation. Adding a second air jet probe opposite the bottom and a C 1202 with 2 x 2 modules can provide flatness, thickness and parallelism with one measurement.

Flatness gage specifications: black granite surface plate, typical 12 in x 12 in x 4 in (inspection Grade A). Three point support provides accuracy to 50 µin. Other plate sizes and accuracies are available. For large parts that are too large to move over a surface plate, the probe can be mounted into a serrated plate that has been lapped flat. This assembly is moved over the part and read out on the air gage readout.

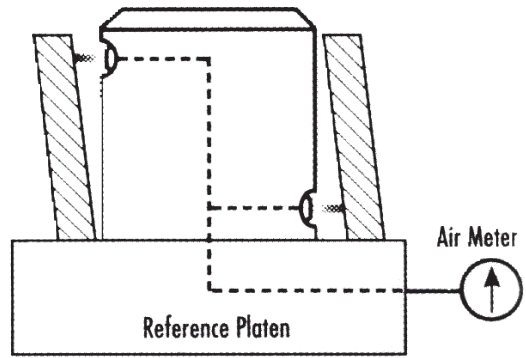

Squareness

Bore-to-face: Method A

A 2-jet air plug having offset jets is mounted square to a platen and is connected to a C 1202 with 2J module. In use the part is rotated 180°. The dynamic MAX-MIN reading provides relative squareness as compared to that of master or a nominal condition workpiece.

Inset shows location of offset air jets on opposite sides of air plug.

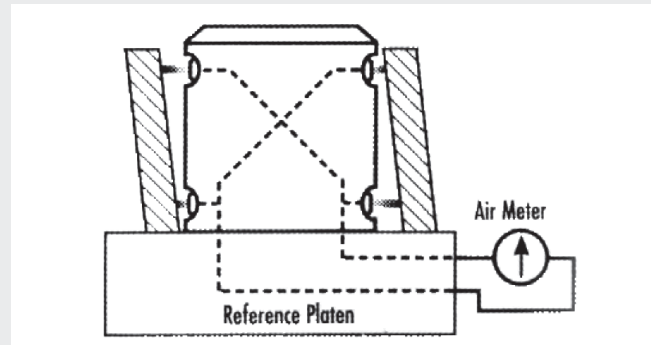

Bore-to-face: Method B

Top and bottom jets on each side of air plug are combined in a C1202 with 2 x 2J air modules to provide differential type measurement. Lack of squareness is indicated by the dynamic MAX-MIN reading as the part is rotated 180° on the reference platen. This method is used primarily when squareness reading should not be influenced by any taper condition. Inset shows two circuits of offset jets on opposite side of the air plug



A 2-jet, 2-circuit base mounted squareness plug provides a fast form measurement result.

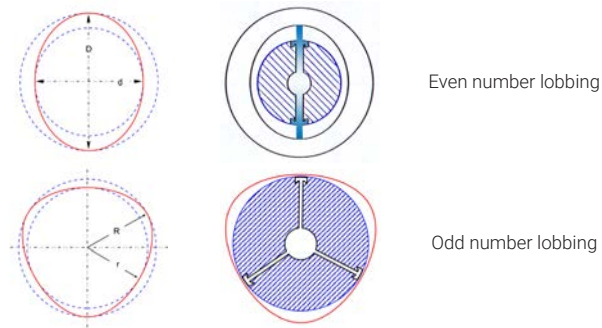
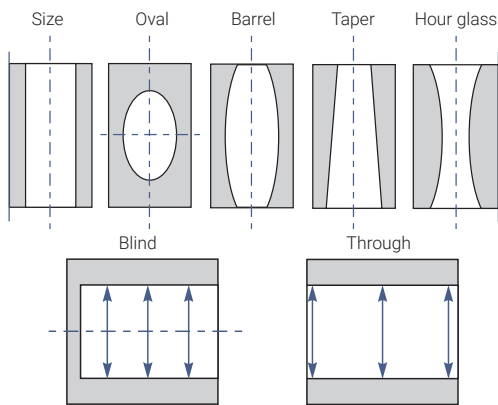

Two point gaging

The most common air plug is designed for two jets offering differential bore measurement for size. Since the jets act differentially, they provide accurate bore measurement for size without regard to position in the bore. With the accuracy built into the air tooling, Mahr ensures that the jets are balanced and they read the same. Because the jets respond differentially, any radial play in line with the jets is canceled out and accurate bore sizes are read. Thus a two jet system can be used to explore the part axially for not only size but by monitoring the change of size barrel, taper or hourglass conditions can be inspected for. When the plug is rotated in the part, the maximum, minimum, average or diameter variation can be recorded.

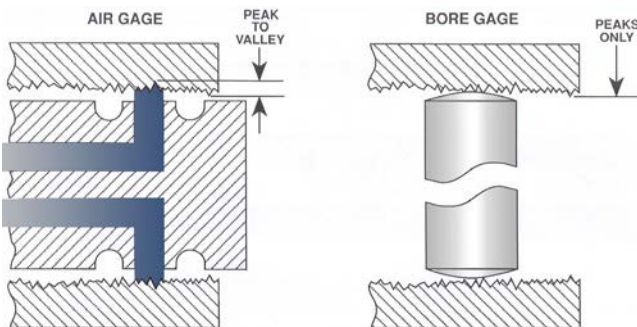

The importance of surface finish

Surface finish is a part characteristic to be considered with air gaging. With tight tolerance parts, surface finish and air gaging go hand in hand for producing reliable results. Since an air gage jet sends out a curtain of air, it covers an area of the part. If the surface finish is large compared to the part tolerance, the air curtain must fill in the deep valleys when building up the air back pressure for measurement. This is unlike a contacting mechanical plug which rides only on the peaks of the surface. To improve correlation between measuring systems, review the maximum surface finish conditions when selecting your air gage system.

Maximum Part Tolerance	Surface Finish (recommended) Ra (Max)
± 50 µm / ± 0.002 in	1.27 µm / 50 µin
± 25 µm / ± 0.001 in	1.27 µm / 50 µin
± 13.5 µm / ± 0.0005 in	0.50 µm / 20 µin
± 5 µm / ± 0.0002 in	0.25 µm / 10 µin
± 5 µm / ± 0.0020 in	0.25 µm / 10 µin
± 2.5 µm / ± 0.0001 in	0.10 µm / 5 µin

Two vs. three point gaging

Often the manufacturing process used to create the bore leaves minor form errors in the bore. As tolerances get tighter, form and surface finish errors become a greater percentage of the tolerance. Therefore, for parts with tight tolerances, it is important to know something about the form of the part prior to selecting two or three jet tooling.

When the part has an even number of lobes, as in the case of an oval shaped part, two jet tooling is ideal for rotational exploration of the part. This rotation will take the plug through the highs and lows of the oval for an indication of size variation. However if the part has an odd number of lobes, as is typical with center-less ground parts where a tri-lobed shape is common, a two jet plug will not be able to measure this diameter change during a gage rotation. Only with a three jet air plug or ring will these lobes be able to be picked up and measured for diameter variation. A 3-jet air plug will check diameters and have odd number lobbing conditions. Plugs can be made to combine a 2-jet and a 3-jet circuits to measure for both even and odd lobbing conditions.



Range of taper gage applications

The use of tapers has never been more important than it is today. In the manufacture of tool holders and spindles, the control of taper and size determines how well the machine can perform during its cutting cycle. In orthopedic parts, the matching of tapers is critical to how well the knee or shoulder replacement will perform. Air gaging is ideal for these applications. Multiple circuit air jets can be placed in very small tapers where no other method can be used to match air gaging speed and performance. Two conditions most important in controlling taper are taper size and angle. Size is controlled by tolerance and is, therefore, identical to a cylindrical ID or OD taper angle, on the other hand, can be controlled by at least three different methods:

1. Included angle or angle per side.
2. Taper per inch or per foot.
3. Controlling two diameters at specified datum locations.

Regardless of the method used, the effect on tapered air gaging is the same, since it produces a differential change between two diameters at a fixed distance apart.

The two styles of tooling are shoulder and jam fit. The function of the tapered part to be measured determines the style.

Jam fit tooling measures taper angle as a differential change between two diameters, ignoring change in taper size. For example, if the tapered size increased by 0.254 mm / 0.010 in, but the angle had not changed, the differential display would indicate no change in reading. These parts have no shoulder or a controlling face and become joined at the point of taper. If a tapered hole is not controlled for size, for example, the mating taper is allowed to drop deeper or ride higher in the hole as the size changes. A typical example is NMTB machine tool tapered spindles and collets.

Shoulder style tooling is capable of checking both taper size and angle simultaneously. Typically, one or both of the parts to be measured will have a shoulder or a face from which the size of the taper is dimensioned. The function of these parts demand that both the size and angle be controlled. Manufacturers of some types of orthopedic joints require that size and angle, and often times run out of the tapered diameter, be measured.

Mahr can provide taper tooling for a wide variety of standard machine tool tapers including ISO7388 and 297 along with tools for checking HSK holders. Contact your Mahr representative for ordering details.

When specifying a taper requirement, always consider:

- What is to be measured?
- Taper angle
- Diameters at certain locations
- Taper and diameter
- Length of taper and possible location for sensing points
- Should the gage be portable or bench mounted?
- What does the operator need for readout?

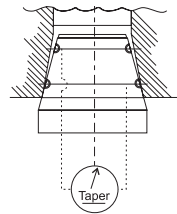

Simple "jam fit" design provides measurement of taper angle.

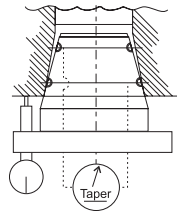

Addition of indicator provides indication of taper diameter.

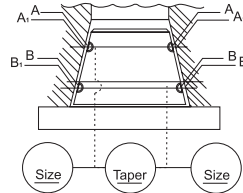

Shoulder style allows for independent circuits providing taper and diameter measurement. Additional third circuit can help determine straightness of taper side.



The Millimar C 1202 differential system with taper air tooling checking machine tool holders and spindles.

Millimar pneumatic length measuring instruments

The requirements for electrical length measuring instruments are just as varied as their applications. Excellent reliability, precision and simple operation are called for. Millimar measuring instruments fulfill all these requirements. These products are rugged, versatile and attractively priced.



Product	μDimensionair
Display	Analog with 1 digital line display
Measuring Channels	Single channel
Compatible Air Tooling	Mahr Inc.
Units	mm, in
Maximum Resolution	0.01 μm/ 0.00002 in
Input Combinations	-
Features	1
Test Steps	1
Dynamic Measurements	Max, Min, Max-Min
Mastering Mode	Nominal or Max/Min
Classification	3 classes
Number of Tolerances / Classes	3 tolerances
Control Inputs and Outputs / SPS Connections	-
Data Interfaces / Ports	USB, ASCII/Digimatic
Configuration	Keypad
Battery Operated	Yes



Millimar C1202 single channel	Millimar C 1202 two channel	Millimar C 1750 PC with Cockpit Software
TFT color display, 110 mm (4.3 in), 480 x 272 pixels	TFT color display, 110 mm (4.3 in), 480 x 272 pixels	10.1 in / 25.65 mm diagonal touch screen
Single channel	Dual channel	128
Mahr Inc.	Mahr Inc.	Mahr Inc.
μm , mm, in, decimal degrees, radians, degrees° min' sec"	μm , mm, in, decimal degrees, radians, degrees° min' sec"	μm , mm, in, decimal degrees
0.01 μm , 0.1 μm , 1 μm / 0.0001 μin , 0.00001 μin , 0.000005 μin	0.01 μm , 0.1 μm , 1 μm / 0.0001 μin , 0.00001 μin , 0.000005 μin	0.01 μm , 0.1 μm , 1 μm / 0.0001 μin , 0.00001 μin , 0.000005 μin
+A, -A, +B, -B, A+B, +A-B, -A+B, -A-B	+A, -A, +B, -B, A+B, +A-B, -A+B, -A-B	Comprehensive formula editor
3	3	128
1	1	6
Max, Min, TIR (Max-Min), (Max+Min) / 2	Max, Min, TIR (Max-Min), (Max+Min) / 2	MAX,MIN,MAX-MIN,(MAX+MIN) / 2, MEAN
		Nominal/Max/Min
		Max 20 classes
5 tolerances	5 tolerances	5 tolerances / Max 20 classes
Control input programmable	Control input programmable	Up to 16 each
USB	USB	USB/RS-232, RS485,W-LAN
Keyboard	Keyboard	Touchscreen / keypad / remote
No, plug in	No, plug in	No



No other pneumatic measuring system is as versatile as the μ Dimensionair, which can be used as a handheld device, a stationary table-top device or even directly on the machine tool. With its IP54 protection rating, it is suitable for use in harsh workshop environments. The compressed air flowing out of the measuring equipment removes any contamination from the test piece to ensure reliable measuring results.

Features:

- Affordable, versatile, innovative, and robust
- Directly and clearly readable measuring results
- With its fixed ratio and controlled compressed air supply, this sturdy, reliable measuring instrument is ideal for use in manufacturing environments
- Choice of setup with one standard or with Min/Max masters
- All other functions of the μ Max μ m II digital dial comparator
- Dynamic measurement: Min, Max, measuring span
- Multiplication factor and hold function
- Choice of data transfer with serial number
- MarConnect data output: USB, Opto RS-232C and Digimatic
- Package contains: instruction manual, supply hose
- MarCom Professional Software free download: www.mahr.com/marcom (only for Mahr data cables and wireless systems with USB and RS232 interface)

Order No.	2103200
Product Type	μ Dimensionair II
Magnification	5000:1, 2500:1, 1260:1
Inputs for Pneumatic Measuring Equipment	1
Digital Display	Rotates through 270°
Storage Temperature MAX	60 °C
Graduation Value	0.5 μ m, 1 μ m, 2 μ m / 0.00002 in, 0.00005 in, 0.0001 in
Display	Analog display with one line digital display
Tolerance Display	Two - over / under (3 class)
Compatibility	Mahr Inc.
Features	1
Programs	1
Test Steps	1
Dynamic Functions	MAX, MIN, MAX-MIN
Statistical Functions	Difference, Nominal Average
Response Time (Air)	Approximately 1 sec.
Error Limit	\pm 1% of the total range
Air Pressure	2.10 \pm .01 bar
Repeatability	\pm 1 μ m numerical increment
Data Interface	Digimatic, Opto RS232C, USB, wireless
Energy Supply	Battery operation, approximately 3000 h
IP Protection Category	IP 54
Dimensions Main Body	100 mm x 60 mm x 70 mm / 4 in x 2.5 in x 3 in

Application:

- Applications with pneumatic measuring equipment requiring mobile measurement and evaluation.

Millimar μ Dimensionair II

Mobile pneumatic length measuring instrument

Accessories

Order No.	Model	Description
2262715		Pressure regulator with filter
2095924		Pressure meter to verify regulator setting
2239307		Universal bench mount
2237666		Handle, ergonomic, 3/8-32, 5 in long (part of scope)
2240993		Shut off slide valve, 3/8-32
2241109		Table stand for μ Dimensionair
2240594		Swivel coupling adapter for rotating tooling
2262714	Replaces AFL-24	Oil and water separator trap
2261277		Kit, replacement connecting air hose, 8M/26'
4102520		Battery 3 V, CR 2032
4346023	2000 USB	2000 USB data connection cable USB (2 m)
4346021	2000 d	Digimatic data cable (2 m)
4346020	2000 r	Data connection cable RS232C (2 m)



2239307



2240993



2241109



2240594



2262715



2095924



2239307 (stand used as a bench stand for air plugs or rings)



The portability of the μ Dimensionair brings the displayed measuring result right to the point of inspection - either on the bench or in the machine.

Millimar C 1202



Compact amplifier

Millimar length measuring instruments are compact, robust, and easy to use. They are versatile evaluation and indicating instruments for measuring tasks of manageable complexity in the production area and in the measuring room.



Applications:

For indicating instrument for precise length measurements:

- For connecting different sensors by way of N 1700 measuring modules
- For connecting up to 2 measuring sensors

Please note: N 1700 measuring modules are necessary additional accessories

Features:

- Versatility for a wide range of measuring tasks
 - N 1700 modules as measuring channels for inductive and incremental probes or for pneumatic measuring equipment
 - High-resolution, high-contrast color display
 - Fully adjustable display for ideal viewing angle
 - 3 measurement value display options available: number, pointer or bar
 - 1 - 3 features can be displayed at once
 - Extremely easy to operate
 - Several measuring tasks can be stored on the memory card
 - Compact housing
 - Suitable for wall mounting
 - **Package includes:** AC adapter, micro SD memory card, operating instructions, excludes N 1700 module (required accessory)
- www.mahr.com/marcom (only for Mahr data cables and wireless systems with USB and RS-232 interface)

Order No.	5312025
Type	C 1202
Display	TFT color display 110 mm (4.3 in), 480 x 272 pixels
Range of Digital Display	$\pm 999,9999 \mu\text{m} / \pm 39.370000 \text{ in}$
Range of Analog Display	$\pm 5000 \mu\text{m}, \pm 2000 \mu\text{m}, \pm 1000 \mu\text{m}, \pm 300 \mu\text{m}, \pm 100 \mu\text{m}, \pm 30 \mu\text{m}, \pm 10 \mu\text{m}, \pm 3 \mu\text{m} / \pm 0.19 \text{ in}, \pm 0.07 \text{ in}, \pm 0.03 \text{ in}, \pm 0.03 \text{ in}, \pm 0.003 \text{ in}, \pm 0.001 \text{ in}, \pm 0.0004 \text{ in}, \pm 0.0001 \text{ in}, \pm 0.0001 \text{ in}$
Digital Resolution	0.01 μm , 0.1 μm , 1 $\mu\text{m} / 0.000005 \text{ in}, 0.00001 \text{ in}, 0.0001 \text{ in}$
Measuring Combinations	+A, -A, +B, -B, A+B, +A-B, -A+B, -A-B
Features	3
Dynamic Functions	Max, Min, Max-Min, (Max+Min)/2, average, length, angle
Configuration	Keyboard
Data Transmission Rate	30 Hz
Refresh Rate	40 fps
Error Limit, Digital Display	0.3 % (min. 0.2 μm)
Error Limit, Analog Display	0.25 % of scale end value / 0.3 % of displayed value
Data Interface	USB, Digimatic
Control Inputs	Programmable control input (functions and function sequences)
Power Supply	AC adapter, 230 V/115 V; 50/60 Hz
IP Protection Class	IP 42

Millimar C 1202

Compact amplifier

Tilting display

Measuring values can be read clearly and effortlessly from all viewing angles. The display also features a backlight.

Sturdy plastic housing

Since the C 1202 is impervious to external influences, it is ideal for use in production.

Interchangeable modules

The C 1202 can be easily converted to handle different measuring tasks.

Interpret measuring results with ease

The high contrast color display provides a clear presentation of the measuring results.

Large keys

The C 1202 can also be reliably operated with gloves. Even dirt does not impede its function.



Flexible setup options

Users can position the instrument on the table or fix it to the wall.

* Excluding N 1700 module (required accessory)

Accessories

Order No.	Model	Description
5331155	N 1701 PF-2500/5000	Module for 1 pneumatic gage head 50/20 tooling, 1,2,3-jet, resolution to 0.1 μm / 5 μin
5331156	N 1701-PF-2500/5000-4J	Module for 1 pneumatic gage head 50/20 tooling, 4-jet, resolution to 0.1 μm / 5 μin
5331157	N 1701 PF-10,000	Module for 1 pneumatic gage head 10 tooling, 1,2,3-jet, resolution to 0.1 μm / 5 μin
2258471	Filter regulator	Filter regulator kit air filter and pressure regulator for Mahr Inc. system
5312950	Extension rail	Extension rail for C 1202 to hold 2 x N 1701-PF
2121730	Base	Base kit to mount C 1202
2262234	Tool mount	Mounting block to hold 2242578 tooling adaptor vertical or horizontal
2242578	Tool adaptor	Tooling holder for low mag tooling
4102603	DK-U1	USB bidirectional data cable (2 m)
4102058	16 ESf	Footswitch for the adoption of measuring values
2262246	Regulator	Regulator for base mount
2262710		Filter element for 2262714 filter/trap

Millimar C 1202 for single channel air gaging

The Millimar C 1202 when combined with one of the three available pneumatic to electronic gaging modules, is the modern new display for air gaging applications. When one channel is required and the appropriate tooling is used, the application for the Millimar C 1202 and one module includes:

- Inside and outside diameters with 1, 2 or 3 jets
- 4-jet tooling or average diameter, straightness or match gaging applications
- When used with the Millimar C 1202 dynamic modes the system will display straightness, flatness, TIR, max or min diameters

The Millimar C 1202 allows for single master zeroing which is typical of Mahr Millimar Dimensionair systems. However, the Millimar C 1202 allows for Min/Max mastering, allowing the display/module to be used with a wide range of air tooling in the market. A wide range of adaptors and air balancing adaptors are available for easy adaptation of non-Mahr air tooling.

The Millimar C 1202 is the replacement for existing single channel Mahr Dimensionair products.



Dimensionair



832 Dimensionair



Dimensionair



C 1245



C 1210



1840



Millimar C 1202

Compact amplifier

Product Cross Reference and Configuration Guides

Order No.	Model	Description
-----------	-------	-------------

Suggested replacement configuration for single input, 1,2 or 3 jet, low mag 50/20 tooling as used with 832 PE, C 1208PE, Dimensionair and Universal Dimensionair

5312025	C1202	Millimar bench evaluation unit with power supply and micro SD card
5331155	N 1701 PF 2500/5000	Module for Mahr Inc. (Federal) air tooling 2500:1 / 5000:1
2258471	Air kit	Air filter / regulator for up to three N 1701 PF modules

Suggested replacement configuration for single input, 1,2 or 3 jet, high mag 10/5 tooling as used with 832 PE, C 1208PE, Dimensionair and Universal Dimensionair

5312025	C1202	Millimar bench evaluation unit with power supply and micro SD card
5331157	N 1701 PF 10,000/20,000	Module for Mahr Inc. (Federal) air tooling 10,000:1 / 20,000:1
2258471	Air kit	Air filter / regulator for up to three N 1701 PF modules

Suggested replacement configuration for single input, 4-jet low mag 50/20 tooling as used with 832 PE, C 1208PE, Dimensionair and Universal Dimensionair

5312025	C1202	Millimar bench evaluation unit with power supply and micro SD card
5331156	N 1701 PF 2500/5000-4J	Module for Mahr Inc. (Federal) air tooling 2500:1 / 5000:1, 4 jet
2258471	Air kit	Air filter / regulator for up to three N 1701 PF modules

Ordering information

5312025	C1202	Millimar bench evaluation unit with power supply and micro SD card
5331155	N 1701 PF 2500/5000	Module for Mahr Inc. (Federal) air tooling low mag 1, 2 or 3 jet, 2500:1 / 5000:1
5331156	N 1701 PF 2500/5000-4J	Module for Mahr Inc. (Federal) air tooling low mag, 4 jet, 2500:1 / 5000:1
5331157	N 1701 PF 10,000/20,000	Module for Mahr Inc. (Federal) air tooling high mag 1, 2 or 3 jet, 10,000:1/20,000:1
2258471	Air kit	Air filter / regulator for up to three N 1701 PF modules

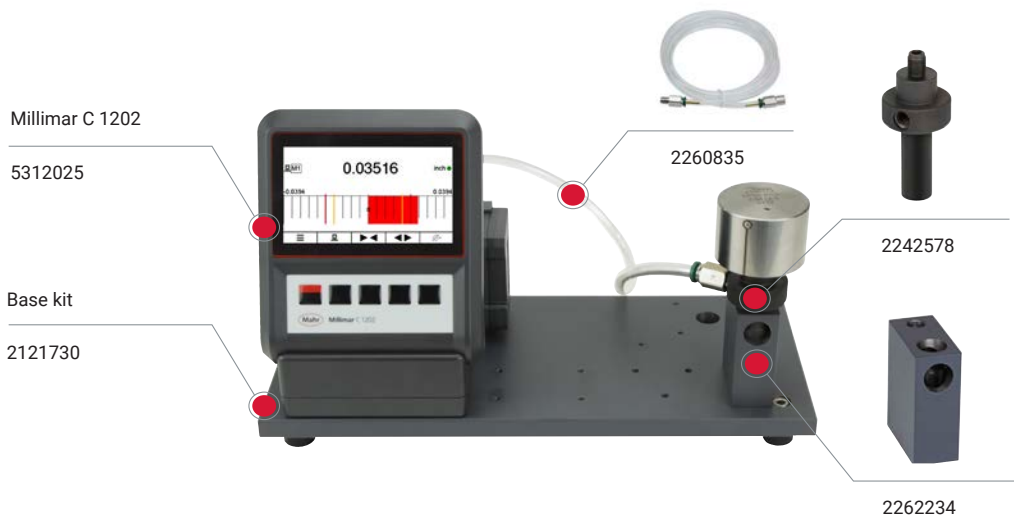

Millimar C 1202 for dual channel air gaging

The Millimar C 1202, when combined with one of the three available pneumatic to electronic gaging modules, is the modern new display for air gaging applications. When one channel is required and the appropriate tooling is used, the application for the Millimar C 1202 and one module includes:

- Inside and outside diameters with 1, 2 or 3 jets
- 4-jet tooling or average diameter, straightness or match gaging applications
- When used with the Millimar C 1202 dynamic modes, the system will display straightness, flatness, TIR, max or min diameters
- For use to two channel taper gages, allowing for display of two diameters and taper angle in deg/min/sec, decimal degrees or radians
- For match gage applications to display deviation from nominal clearance or actual clearance

The Millimar C 1202 allows for single master zeroing which is typical of Mahr Millimar Dimensionair systems. However, the Millimar C 1202 allows for Min/Max mastering, allowing the display/module to be used with a wide range of air tooling in the market. A wide range of adaptors and air balancing adaptors are available for easy adaptation of non-Mahr air tooling.

The Millimar C 1202 is the replacement for existing single channel Mahr Dimensionair products.



C 1245



1841



832



Dimensionair



Millimar C 1202

Compact amplifier

Product Cross Reference and Configuration Guides

Order No.	Model	Description
-----------	-------	-------------

Suggested replacement configuration for single input, 1,2 or 3 jet, low mag 50/20 tooling as used with 832 PE, C 1208 PE, Dimensionair, taper, match gage applications

5312025	C1202	Millimar bench evaluation unit with power supply and micro SD card
5331155	N 1701 PF 2500/5000	Module for Mahr Inc. (Federal) air tooling 2500:1 / 5000:1
2258471	Air kit	Air filter / regulator for up to three N 1701 PF modules
5312950	Extension rail	Extension rail kit to hold 2 x N 1701 PF modules

Suggested replacement configuration for single input, 1,2 or 3 jet, high mag 10/5 tooling as used with 832 PE, C 1208 PE, Dimensionair, taper, match gage applications

5312025	C1202	Millimar bench evaluation unit with power supply and micro SD card
5331157	N 1701 PF 10,000/20,000	Module for Mahr Inc. (Federal) air tooling 10,000:1 / 20,000:1
2258471	Air kit	Air filter / regulator for up to three N 1701 PF modules
5312950	Extension rail	Extension rail kit to hold 2 x N 1701 PF modules

Suggested replacement configuration for single input, 4-jet low mag 50/20 tooling as used with 832 PE, C 1208 PE, Dimensionair and Universal Dimensionair

5312025	C1202	Millimar bench evaluation unit with power supply and micro SD card
5331156	N 1701 PF 2500/5000-4J	Module for Mahr Inc. (Federal) air tooling 2500:1 / 5000:1, 4 jet
2258471	Air kit	Air filter / regulator for up to three N 1701 PF modules

Ordering information

5312025	C1202	Millimar bench evaluation unit with power supply and micro SD card
5331155	N 1701 PF 2500/5000	Module for Mahr Inc. (Federal) air tooling low mag 1, 2 or 3 jet, 2500:1 / 5000:1
5331156	N 1701 PF 2500/5000-4J	Module for Mahr Inc. (Federal) air tooling low mag, 4 jet, 2500:1 / 5000:1
5331157	N 1701 PF 10,000/20,000	Module for Mahr Inc. (Federal) air tooling high mag 1, 2 or 3 jet, 10,000:1 / 20,000:1
2258471	Air kit	Air filter / regulator for up to three N 1701 PF modules
5312950	Extension rail	Extension rail kit to hold 2 x N 1701 PF modules



Flexible measurement in production the Millimar family

The components in the Millimar series are optimized to make measuring processes in production as easy and accurate as possible. This is made possible predominantly by the customized assembly of the measuring devices – because each production environment has different areas of focus, as well as, spatial features and requirements relevant to measurement.

- Flexible and modular product combinations to tackle customer specific measuring task
- Different modules for a variety of measuring requirements
- A broad selection of measuring sensors makes it possible to perform a variety of measuring tasks
- For use in a wide variety of applications
- Extremely high data transfer rates mean success with highly dynamic measurements



Pneumatic module in use with a nozzle ring gage



Shaft measurement with inductive modules

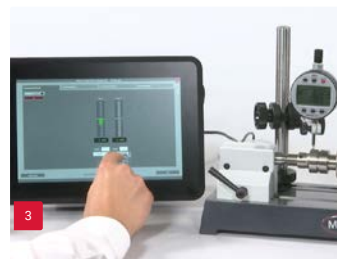

Radial run out measurement with dial indicator



Pneumatic module in use with a nozzle plug gage

Fully universal software for complex measuring tasks

A smart and fully universal interface tool, not only does the Millimar Cockpit Software feature default standard formula for all common measuring task, but it is also possible to perform complex and customized measurements.

The Cockpit Software allows you to access previously saved programs, enabling you to start a measurement without having to input the settings yourself. This saves time while avoiding potential sources of error encountered when carrying out the settings manually.

The default settings currently include nine main measuring task areas. In addition, customized default settings can be stored by the user for subsequent use and repeated measurements.

- Pneumatic module in use with an air ring gage
- Shaft measurement with inductive modules
- Radial run out measurement with dial indicator
- Pneumatic module in use with an air plug gage

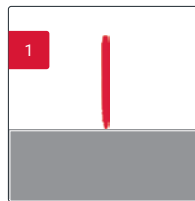

Thickness

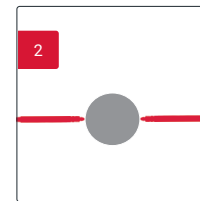

Compound

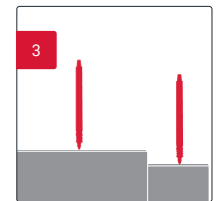

Difference

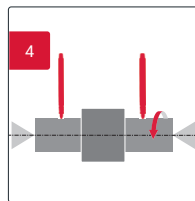

Coaxiality

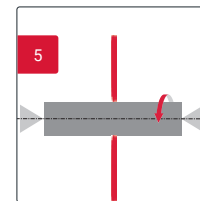

Ovality

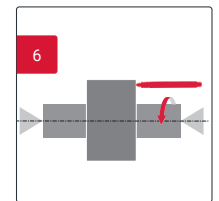

Radial run-out

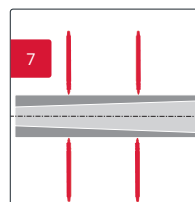

Conicity

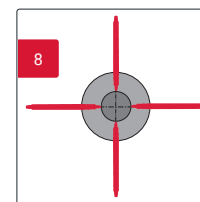

Concentricity

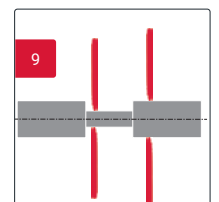

Symmetry offset

Millimar Cockpit 13



Measuring software to run on your Windows PC

The Millimar Cockpit Software is an intelligent and versatile software for complex measuring tasks in the production area that not only offers preset standard formulae for all the most common measuring tasks, but it is also possible to perform complex and customized measurements.

Features

- Versatility for a wide range of measuring tasks
- N 1700 modules as measuring channels for inductive and incremental probes or for pneumatic measuring equipment
- High-resolution, high-contrast color display
- Fully adjustable display for ideal viewing angle
- Multiple measurement value display options available: bar graph, horizontal bar graph, digital display, and analog display
- Multiple features can be displayed at once
- Extremely easy to operate
- Several measuring tasks can be stored on the memory card
- Compact housing
- Suitable for wall mounting
- Package includes: AC adapter, micro SD memory card, operating instructions, excludes N 1700 module (required optional accessory) www.mahr.com/marcom (only for Mahr data cables and wireless systems with USB and RS-232 interface)

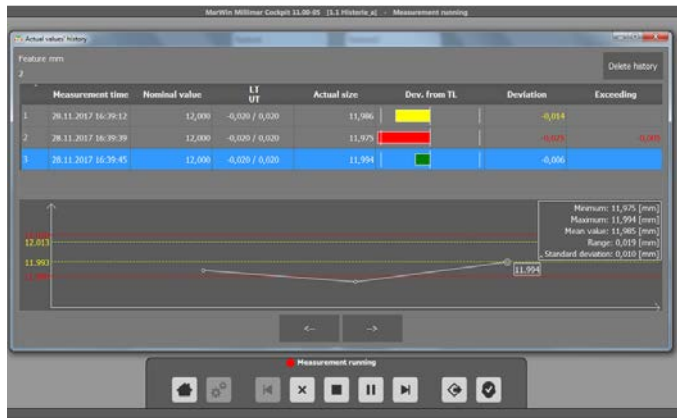

History view offers offline review and trends of collected measurements

Accessories

Order No.	Description	Compatibility
5312802	Software option: measure history	USB, Integrated Wireless, Millimar N 1700

Order No.	5312865
Model	Millimar Cockpit 13
Range of Analog Display	$\pm 10000 \mu\text{m}$, $\pm 5000 \mu\text{m}$, $\pm 2000 \mu\text{m}$, $\pm 1000 \mu\text{m}$, $\pm 500 \mu\text{m}$, $\pm 200 \mu\text{m}$, $\pm 100 \mu\text{m}$, $\pm 50 \mu\text{m}$, $\pm 20 \mu\text{m}$, $\pm 10 \mu\text{m}$ / $\pm 0.5 \text{ in}$, $\pm 0.2 \text{ in}$, $\pm 0.1 \text{ in}$, $\pm 0.05 \text{ in}$, $\pm 0.02 \text{ in}$, $\pm 0.0 \text{ in}$, $\pm 0.005 \text{ in}$, $\pm 0.002 \text{ in}$, $\pm 0.001 \text{ in}$, $\pm 0.0005 \text{ in}$, tolerance related
Resolution	$10 \mu\text{m}$, $1 \mu\text{m}$, $0.1 \mu\text{m}$, $0.01 \mu\text{m}^*$ / 0.0001 in , 0.00001 in , 0.000001 in , 0.0000001 in^* (*only with N 1702 M-HR)
Display	Vertical bar graph, horizontal bar graph, analog display or round scale, digital display Any combination of display types can be chosen for each feature
Tolerance Display	Upper and lower tolerance limit (per feature), upper and lower warning limit (per feature)
Compatibility	USB, Integrated Wireless, Millimar N 1700
Measuring Combination	Predefined formula templates for standard features Links entered via comprehensive formula editor
Features	128
Classification	Max. 20 classes



Formula creation

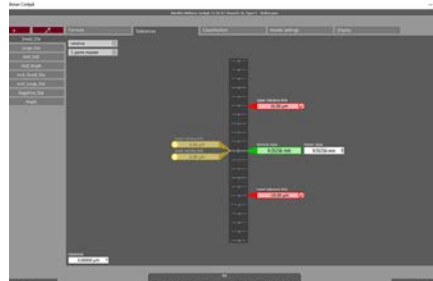

Tolerance setting

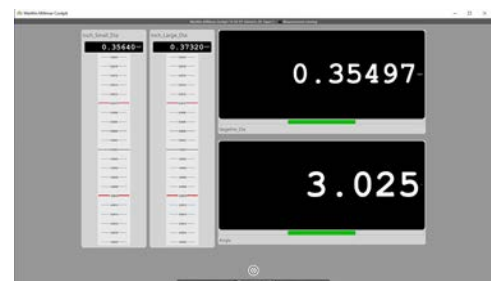

Screen layout

Millimar C 1750 PC

Gaging computer

The Millimar product family offers state-of-the-art metrology: modular, precise, flexible and user-friendly. This makes Millimar perfect for modern and quality-conscious manufacturing.



Features

- Interactive, touch-capable software
- Simple and intuitive user interface
- User-friendly setup of measuring tasks
- Simple operation via predefined formulas for most common features
- Management of measuring tasks
- Assignment of pictures or drawings per measuring task
- Static and dynamic measurements
- Supported by graphical control elements
- Live-indication of measuring values and features
- Digital and analog displays for simultaneous indication of up to 128 features
- Connection of Millimar N 1700 modules in combination with inductive probes as well as Mahr instruments with data interface
- Connection of Mahr instruments with Integrated Wireless
- Data export in MS-Excel or in qs-Stat format (dfq, dfx or dfd format)
- Password protected user levels (3 levels)
- Online help (operating instruction) integrated in Cockpit Software
- Package contains: Millimar Cockpit Software including: 10.1" Touch-PC, preinstalled Windows 10 IoT Enterprise, Mahr license key, installation disk, recovery-Stick 16 GB, operating instructions (online help), power source, VESA 100 standard stand



N 1700 modules provide signal sharing from and input/output control



N 1750 PC is a powerful solution of multiple input air gaging applications

Order No.	5312870
Length Units	mm, µm, in
Feature Types	Length, angle, dimensionless
Angle Units	Degrees, radians
Product Type	C 1750 PC
Range of Analog Display	± 10000 µm, ± 5000 µm, ± 2000 µm, ± 1000 µm, ± 500 µm, ± 200 µm, ± 100 µm, ± 50 µm, ± 20 µm, ± 10 µm / ± 0.5 in, ± 0.2 in, ± 0.1 in, ± 0.05 in, ± 0.02 in, ± 0.0 in, ± 0.005 in, ± 0.002 in, ± 0.001 in, ± 0.0005 in, tolerance related
Resolution	10 µm, 1µm, 0.1 µm, 0.01µm* / 0.0001 in, 0.00001 in, 0.000001 in, 0.0000001 in* (*only with N 1702 M-HR)
Display	Vertical and horizontal bar graphs, analog display or round scale, digital display any combination of display types can be chosen for each feature
Tolerance Display	Upper and lower tolerance limit (per feature), upper and lower warning limit (per feature)
Compatibility	USB, Integrated Wireless, Millimar N 1700
Measuring Combination	Pre-defined formula templates for standard features and links entered via comprehensive formula editor
Features	128
Dynamic Functions	MAX, MIN, MAX-MIN, MAX+MIN
Classification	Maximum 20 classes
Energy Supply	100-240V AC/DC active switching; 12V DC-Out
IP Protection Category	IP 65 (front panel)

Outstanding in performance

The products in the Millimar portfolio show just how flexible modern metrology can be. The key to this is the modular setup of the N 1700 evaluation units and the fully universal Cockpit Software. In addition, the wide range of probes and accessories enables other versatile applications. Specifically designed for your production environment, Millimar products guarantee more efficient work and more convenient measurement.

All RS-485 bus modules in the Millimar N 1700 series can be individually combined with one another. The modules can be connected to all probe types in the Mahr portfolio. Measurement uncertainty is considerably reduced because of the high rate of data transfer, enabling highly dynamic measurements to be completed.



5331130



5331155



5331120



5331140



5331134



5331133

Accessories for Millimar N 1700 Cockpit

Order No.	Model	Description
5331130	N 1701 USB	Connecting module, includes USB cable
5331155	N 1701-PF-2500/5000	Module for 1 pneumatic gage head 50/20 tooling, 1,2,3-jet, resolution to 0.1 µm/5 µin
5331156	N 1701-PF-2500/5000-4J	Module for 1 pneumatic gage head 50/20 tooling, 4-jet, resolution to 0.1 µm/5 µin
5331157	N 1701-PF-10,000	Module for 1 pneumatic gage head 10 tooling, 2-jet, resolution to 0.1 µm/5 µin
5331133	N 1701 PS	Power supply module
5331120	N 1702 M	Module for 2 Mahr inductive probes
5331140	N 1704 M	Module for 4 Mahr inductive probes
5331134	N 1704 I/O	Module for 4 in / 4 out control
2258471	Filter regulator	Filter regulator kit air filter and pressure regulator for Mahr Inc. system
5331161	N 1702 VPP	Module for digital probes
4102058	16 ESf	Footswitch
4102220	i-Stick	Wireless receiver for MarCom

Note: Mahr offers additional modules for competitive probes (Marposs, TESA) and other gaging applications.

Air tooling selection guide

Air gaging has been the solution for measuring tight tolerances on the shop floor for decades. While Dimensionair tooling has been manufactured for years, the display units have greatly improved in capabilities and performance over the years. Analog displays, once the staple of most gaging applications, are now being replaced by Millimar displays and computer based systems. Today's readouts are faster, have more capabilities and provide data collection with more value than ever before.

Analog systems vs. digital displays

While analog systems are an excellent and fast indication of degree of good or bad, they do have some limitation. Analog meter response, interpretation of graduation and lack of data for process documentation are just a few examples of analog meter limitations. The biggest hindrance is the range vs. resolution problem with analog meters. With analog devices, one is faced having longer measuring ranges with coarser graduation but when one needs higher resolution, the measuring range becomes shorter. Digital displays, on the other hand, offer long measuring range and sometimes higher resolution than were possible with analog systems.

Legacy terminology

Since analog systems were the display of choice for 40 years, until digital based products came to the market, the tooling was often specified based on the analog meter used – balancing range and resolution for the application. While many of the terms used today are carried over from the analog display world, most commonly magnification, digital products have the flexibility to use multiple tooling styles.

Clearance and measuring range

As with mechanical plug gaging, clearance is used as the way to specify the proper plug for the application. As part diameters get smaller, plug clearance can have an effect on centralization and effect performance. Therefore, understanding important measurement parameters are required to apply the correct air tool.

When selecting air gaging one must know:

- Size to be measured
- Surface finish
- Through or blind hole
- Centralization error
- Material of the part
- Tolerance
- Location of the check
- Length of bore
- Part geometry
- Volume of parts gaged

Because air tooling is manufactured for the specific application, it is critical that the tooling be specified correctly to ensure successful use. Tooling specified incorrectly is not returnable. Therefore it is important to understand the application and specification. Detailed ordering information is available at the end of this catalog to assist.



Maximum Part Tolerance * (recommended)	Digital Minimum Graduation	Ref: Magnification	Tooling ID No.	Range *	Surface Finish Ra (Max) (recommended)	Minimum Through Hole Length **	Minimum Blind Hole Length **	Minimum Super Blind Hole Length **	Order No. N 1702 PF
± 50 µm / ± 0.002 in	0.2 µm / 10 µin	Contact Mahr Tech Support	60	± 76 µm / ± 0.003 in	1.27 µm / 50 µin	1.8 mm / 0.070 in	6.35 mm / 0.250 in	2.79 mm / 0.110 in	Option
± 25 µm / ± 0.001 in	0.1 µm / 5 µin	2500:1 / 4000:1 low mag	50	± 38 µm / ± 0.0015 in	1.27 µm / 50 µin	1.8 mm / 0.070 in	6.35 mm / 0.250 in	2.79 mm / 0.110 in	5331155
± 13.5 µm / ± 0.0005 in	0.1 µm / 5 µin	5000:1 / 8000:1 low mag	20	± 19 µm / ± 0.00075 in	0.50 µm / 20 µin	1.8 mm / 0.070 in	6.35 mm / 0.250 in	2.79 mm / 0.110 in	5331155
± 5 µm / ± 0.0002 in	0.1 µm / 5 µin	5000:1 / 8000:1 low mag	20+	± 19 µm / ± 0.00075 in	0.25 µm / 10 µin	1.8 mm / 0.070 in	6.35 mm / 0.250 in	2.79 mm / 0.110 in	5331155
± 5 µm / ± 0.0002 in	0.1 µm / 5 µin	10000:1 / 16000:1 high mag	10	± 7.6 µm / ± 0.0003 in	0.25 µm / 10 µin	1.14 mm / 0.045 in	3.18 mm / 0.125 in	1.9 mm / 0.075 in	5331157
± 2.5 µm / ± 0.0001 in	0.1 µm / 5 µin	20000:1 / 32000:1 high mag	5	± 3.8 µm / ± 0.00015 in	0.10 µm / 5 µin	1.14 mm / 0.045 in	3.18 mm / 0.125 in	1.9 mm / 0.075 in	5331157

Notes: When choices are DP50 or DP20, for least centralizing error use DP20, for sizes under 0.37 in / 9.50 mm.

Unless part dimension requires small jetting of high mag system – recommendation would be low mag as this is more cost competitive.

* Low mag air plugs under 0.248 in / 6.3 mm have less range than the meter. Use 2/3 of the range for tolerance.

** Low mag air plugs under 0.248 in / 6.3 mm require more bore length.

+ Special body clearance may be recommended

Millimar Air plugs

Plug identification

Air plugs are marked with an item number and an identification number. This unique marking identifies its size, number of jets, plug style, and the Dimensionair system the plug should be used with.

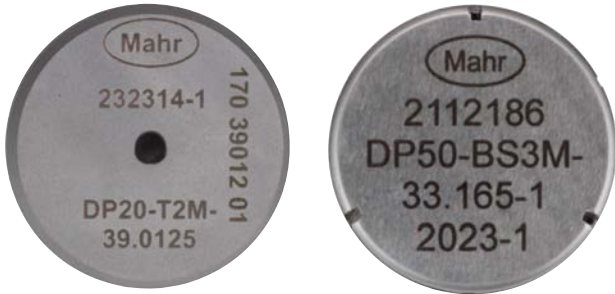

For example, on the left the standard air plug item number is 232314-1. It's unique identifier is DP20-T2M-39.0125. The DP20 signifies the plug for standard magnifications (20) through-hole style with two jets, metric(-T2M), and 39.0125 nominal size (-39.0125). This plug is used with Mahr Millimar air systems having the marking (20) or 2500/5000. Optionally, customer markings (170 39012 01) can be added.

On the right the 2112186 is the item number, the unique is DP50-BS3M-33.165-1. The DP50 signifies the plug for standard magnifications (50) blind hole, special with two jets, metric (-BS2M), and 33.165-1 nominal size (-33.165). This plug is used with Mahr Millimar air systems having the marking (50) or 2500/5000.

Features:

- Calibrated air tooling for the Millimar Dimensionair air gaging systems
- Air tooling is interchangeable without adjusting system magnification
- Mahr air plugs have large clearance (see table), allowing easy entrance into the hole being measured and greater measuring range
- Long life - wide clearance and high chrome content steel or AlChrNi coatings extends life of the air plug
- Deep, recessed jets - air jets are recessed into the plug body which protects them from damage
- Large jet size eliminates clogging from dirt and oil

When ordering new or replacement air plugs please specify:

- From existing tooling the item and unique identifier
- Nominal size and tolerance
- Air system the plug is being used with
- Air plug style – through, blind or other specific
- Standard HCC material or options coating
- It is recommended to purchase master at the same time with its size, class, material and certification
- Unless otherwise specified, Mahr will furnish a 2-jet, through hole, high chrome air plug for a 2500:1 (50) display system



Blind hole

Through hole

Coated through hole

Plug Interchangeability and Clearances

Tool ID	Nominal Size Above	To and Include	Clearance From Nominal Size
60	3.0 mm / 0.118 in	3.6 mm / 0.14 in	0.030 mm / 0.0012 in
	3.6 mm / 0.14 in	4.7 mm / 0.185 in	0.046 mm / 0.0018 in
	4.7 mm / 0.185 in	6.0 mm / 0.236 in	0.061 mm / 0.0024 in
	6.0 mm / 0.236 in	59.9 mm / 2.36 in	0.081 mm / 0.0032 in
	59.9 mm / 2.36 in	74.9 mm / 2.95 in	0.081 mm / 0.0032 in
	74.9 mm / 2.95 in	127 mm / 5 in	0.089 mm / 0.0035 in
50	Above 127 mm / 5 in		0.107 mm / 0.0042 in
	3.0 mm / 0.118 in	3.6 mm / 0.14 in	0.020 mm / 0.0008 in
	3.6 mm / 0.14 in	4.7 mm / 0.185 in	0.028 mm / 0.0011 in
	4.7 mm / 0.185 in	6.0 mm / 0.236 in	0.033 mm / 0.0013 in
	6.0 mm / 0.236 in	59.9 mm / 2.36 in	0.056 mm / 0.0022 in
	59.9 mm / 2.36 in	74.9 mm / 2.95 in	0.071 mm / 0.0028 in
20	74.9 mm / 2.95 in	127 mm / 5 in	0.071 mm / 0.0028 in
	3.0 mm / 0.118 in	3.6 mm / 0.140 in	0.015 mm / 0.0006 in
	3.6 mm / 0.14 in	4.7 mm / 0.185 in	0.018 mm / 0.0007 in
	4.7 mm / 0.185 in	6.0 mm / 0.236 in	0.020 mm / 0.0008 in
	6.0 mm / 0.236 in	59.9 mm / 2.36 in	0.033 mm / 0.0013 in
	59.9 mm / 2.36 in	74.9 mm / 2.95 in	0.071 mm / 0.0028 in
10	74.9 mm / 2.95 in	127 mm / 5 in	0.071 mm / 0.0028 in
	Above 127 mm / 5 in		0.081 mm / 0.0032 in
10	1.57 mm / 0.062 in	44.4 mm / 1.75 in	0.009 mm / .00035 in
	Above 44.4 mm / 1.75 in		0.014 mm / .00055 in
5	For all sizes up to 25.4 mm / 1 in		0.005 mm / 0.0002 in

Through hole plugs

(DP50 and DP20)

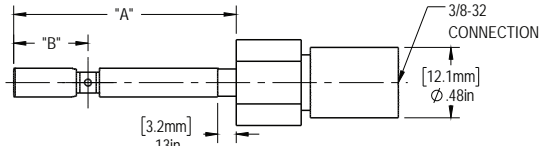

3.00 mm - 6.00 mm / 0.118 in - 0.236 in (2115000)
Minimum recommended hole length: 4.75 mm / 0.187 in

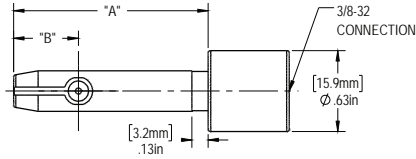

6.00 mm - 10.00 mm / 0.236 in - 0.394 in (2115001)
Minimum recommended hole length: 6.35 mm / 0.250 in
With guide sleeve or stop collar: 1.8 mm / 0.07 in

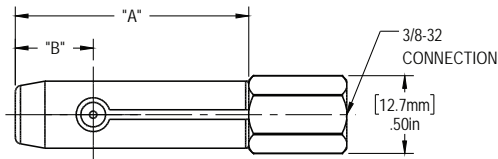

10.00 mm - 13.00 mm / 0.394 in - 0.512 in (2115002)
Minimum recommended hole length: 6.35 mm / 0.250 in
With guide sleeve or stop collar: 1.8 mm / 0.07 in
Extensions for deep holes.

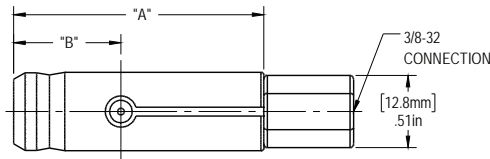

13.00 mm - 15.00 mm / 0.512 in - 0.590 in (2115003)
Minimum recommended hole length: 6.35 mm / 0.250 in
With guide sleeve or stop collar: 1.8 mm / 0.07 in
May be used with AEX-1 or -2. Extensions for deep holes.

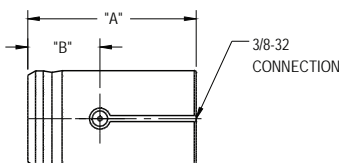

15.00 mm - 40.00 mm / 0.590 in - 1.575 in (2115004)
Minimum recommended hole length: 6.35 mm / 0.250 in
With guide sleeve or stop collar: 1.8 mm / 0.07 in

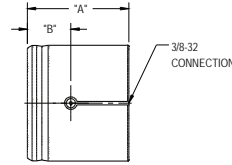

40.00 mm - 60.00 mm / 1.575 in - 2.362 in (2115005)
Minimum recommended hole length: 6.35 mm / 0.250 in
With guide sleeve or stop collar: 1.8 mm / 0.07 in
May be used with AHA-4 or -5. Extensions for deep holes.

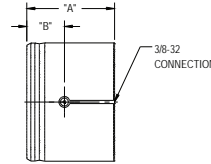

60.00 mm - 75.00 mm / 2.362 in - 2.953 in (2115006)
Minimum recommended hole length: 6.35 mm / 0.250 in
With guide sleeve or stop collar: 1.8 mm / 0.07 in
May be used with AHA-4 or -5. Extensions for deep holes.

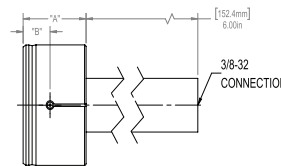

75.00 mm - 90.00 mm / 2.953 in - 3.534 in (2115007)
Minimum recommended hole length: 6.35 mm / 0.250 in
With guide sleeve or stop collar: 1.8 mm / 0.07 in

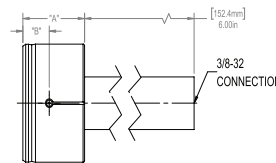

90.00 mm - 100.00 mm / 3.534 in - 3.937 in (2115008)
Minimum recommended hole length: 6.35 mm / 0.250 in
With guide sleeve or stop collar: 1.8 mm / 0.07 in

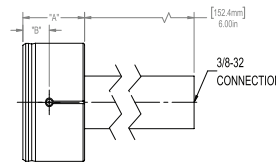

100.00 mm - 115.00 mm / 3.937 in - 4.528 in (2115009)
Minimum recommended hole length: 6.35 mm / 0.250 in
With guide sleeve or stop collar: 1.8 mm / 0.07 in

Order No.	Above	To and Include	"A" Overall Length	"B" Jet Centerline	Minimum Hole Length*	Measuring Range DP50	Measuring Range DP20
2115000	3.00 mm / 0.118 in	3.56 mm / 0.140 in	38.10 mm / 1.500 in	12.70 mm / 0.500 in	4.75 mm / 0.187 in	0.025 mm / 0.0010 in	0.013 mm / 0.0005 in
2115000	3.56 mm / 0.140 in	4.70 mm / 0.185 in	38.10 mm / 1.500 in	12.70 mm / 0.500 in	4.75 mm / 0.187 in	0.038 mm / 0.0015 in	0.0200 mm / 0.00075 in
2115000	4.70 mm / 0.185 in	6.00 mm / 0.236 in	38.10 mm / 1.500 in	12.70 mm / 0.500 in	4.75 mm / 0.187 in	0.051 mm / 0.0020 in	0.025 mm / 0.0010 in
2115001	6.00 mm / 0.236 in	10.00 mm / 0.394 in	38.10 mm / 1.500 in	12.70 mm / 0.500 in	6.35 mm / 0.250 in	0.076 mm / 0.0030 in	0.038 mm / 0.0015 in
2115002	10.00 mm / 0.394 in	13.00 mm / 0.512 in	38.10 mm / 1.500 in	12.70 mm / 0.500 in	6.35 mm / 0.250 in	0.076 mm / 0.0030 in	0.038 mm / 0.0015 in
2115003	13.00 mm / 0.512 in	15.00 mm / 0.590 in	44.45 mm / 1.750 in	19.05 mm / 0.750 in	6.35 mm / 0.250 in	0.076 mm / 0.0030 in	0.038 mm / 0.0015 in
2115004	15.00 mm / 0.590 in	40.00 mm / 1.575 in	44.45 mm / 1.750 in	19.05 mm / 0.750 in	6.35 mm / 0.250 in	0.076 mm / 0.0030 in	0.038 mm / 0.0015 in
2115005	40.00 mm / 1.575 in	60.00 mm / 2.362 in	44.45 mm / 1.750 in	19.05 mm / 0.750 in	6.35 mm / 0.250 in	0.076 mm / 0.0030 in	0.038 mm / 0.0015 in
2115006	60.00 mm / 2.362 in	75.00 mm / 2.953 in	44.45 mm / 1.750 in	19.05 mm / 0.750 in	6.35 mm / 0.250 in	0.076 mm / 0.0030 in	0.038 mm / 0.0015 in
2115027	75.00 mm / 2.953 in	90.00 mm / 3.534 in	44.45 mm / 1.750 in	19.05 mm / 0.750 in	6.35 mm / 0.250 in	0.076 mm / 0.0030 in	0.038 mm / 0.0015 in
2115028	90.00 mm / 3.534 in	100.00 mm / 3.937 in	44.45 mm / 1.750 in	19.05 mm / 0.750 in	6.35 mm / 0.250 in	0.076 mm / 0.0030 in	0.038 mm / 0.0015 in
2115029	100.00 mm / 3.937 in	115.00 mm / 4.528 in	44.45 mm / 1.750 in	19.05 mm / 0.750 in	6.35 mm / 0.250 in	0.076 mm / 0.0030 in	0.038 mm / 0.0015 in

* If a guide sleeve or stop collar is used, minimum hole length can be as small as 1.78 mm / 0.070 in for holes larger than 6.30 mm / 0.248 in.
Note: A handle 152 mm / 6 in long and 33.3 mm / 1.31 in diameter is supplied with plugs over 75.0 mm / 2.953 in.

Blind hole/counterbore plugs

(DP50 and DP20)

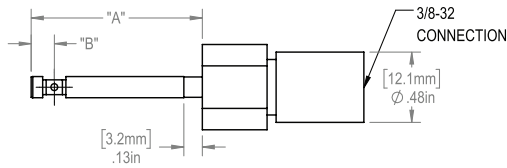

3.00 mm - 6.00 mm / 0.118 in - 0.236 in (2115007)

Minimum recommended hole length: 6.35 mm / 0.250 in
Masters must simulate workspace for holes this size.

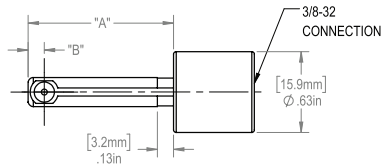

6.00 mm - 10.00 mm / 0.236 in - 0.394 in (2115008)

Minimum recommended hole length: 6.35 mm / 0.250 in
Shorter bores can be checked.

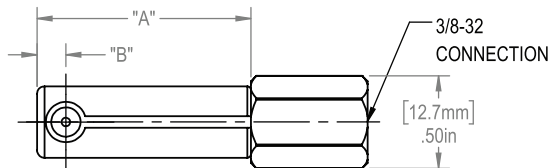

10.00 mm - 13.00 mm / 0.394 in - 0.512 in (2115009)

Minimum recommended hole length: 6.35 mm / 0.250 in
May be used with AHA-28 Extension for deep holes. Shorter bores can be checked.

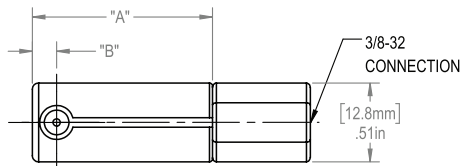

13.00 mm - 15.00 mm / 0.512 in - 0.590 in (2115010)

Minimum recommended hole length: 6.35 mm / 0.250 in
May be used with AEX-1 or -2. Extensions for deep holes. Shorter bores can be checked.

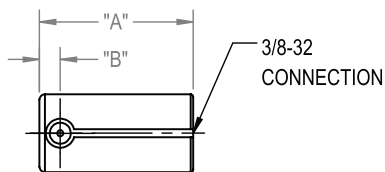

15.00 mm - 40.00 mm / 0.590 in - 1.575 in (2115011)

Minimum recommended hole length: 6.35 mm / 0.250 in
May be used with AHA-4 or -5. Extensions for deep holes. Shorter bores can be checked.

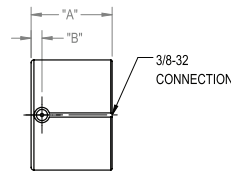

40.00 mm - 60.00 mm / 1.575 in - 2.362 in (2115012)

Minimum recommended hole length: 6.35 mm / 0.250 in
May be used with AHA-4 or -5. Extensions for deep holes. Shorter bores can be checked.

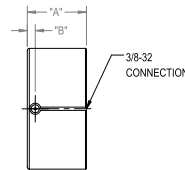

60.00 mm - 75.00 mm / 2.362 in - 2.953 in (2115013)

Minimum recommended hole length: 6.35 mm / 0.250 in
May be used with AHA-4 or -5. Extensions for deep holes. Shorter bores can be checked.

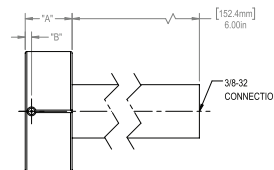

75.00 mm - 90.00 mm / 2.953 in - 3.534 in (2115030)

Minimum recommended hole length: 6.35 mm / 0.250 in

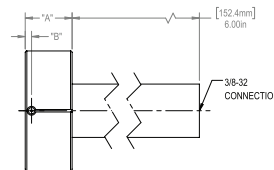

90.00 mm - 100.00 mm / 3.534 in - 3.937 in (2115031)

Minimum recommended hole length: 6.35 mm / 0.250 in

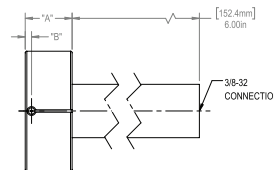

100.00 mm - 115.00 mm / 3.937 in - 4.528 in (2115032)

Minimum recommended hole length: 6.35 mm / 0.250 in

Super blind plugs

Blind hole air plugs can be furnished to check shorter holes than listed above, and can be furnished to check closer to the bottom of a hole. Holes must be at least 1.91 mm / 0.075 in long, and the distance from the end of the plug to the center-line of the jets can be as short as 1.40 mm / 0.055 in for plugs below 6.34 mm / 0.250 in or 1.14 mm / 0.045 in for plugs above 6.34 mm / 0.250 in.

Order No.	Above	To and Include	"A" Overall Length	"B" Jet Centerline	Minimum Hole Length*	Measuring Range DP50	Measuring Range DP20
2115007	3.00 mm / 0.118 in	3.56 mm / 0.140 in	29.36 mm / 1.156 in	3.96 mm / 0.156 in	6.35 mm / 0.250 in	0.025 mm / 0.0010 in	0.013 mm / 0.0005 in
2115007	3.56 mm / 0.140 in	4.70 mm / 0.185 in	329.36 mm / 1.156 in	3.96 mm / 0.156 in	6.35 mm / 0.250 in	0.038 mm / 0.0015 in	0.0200 mm / 0.00075 in
2115007	4.70 mm / 0.185 in	6.00 mm / 0.236 in	29.36 mm / 1.156 in	3.96 mm / 0.156 in	6.35 mm / 0.250 in	0.051 mm / 0.0020 in	0.025 mm / 0.0010 in
2115008	6.00 mm / 0.236 in	10.00 mm / 0.394 in	29.36 mm / 1.156 in	3.96 mm / 0.156 in	6.35 mm / 0.250 in	0.076 mm / 0.0030 in	0.038 mm / 0.0015 in
2115009	10.00 mm / 0.394 in	13.00 mm / 0.512 in	29.36 mm / 1.156 in	3.96 mm / 0.156 in	6.35 mm / 0.250 in	0.076 mm / 0.0030 in	0.038 mm / 0.0015 in
2115010	13.00 mm / 0.512 in	15.00 mm / 0.590 in	29.36 mm / 1.156 in	3.96 mm / 0.156 in	6.35 mm / 0.250 in	0.076 mm / 0.0030 in	0.038 mm / 0.0015 in
2115011	15.00 mm / 0.590 in	40.00 mm / 1.575 in	29.36 mm / 1.156 in	3.96 mm / 0.156 in	6.35 mm / 0.250 in	0.076 mm / 0.0030 in	0.038 mm / 0.0015 in
2115012	40.00 mm / 1.575 in	60.00 mm / 2.362 in	29.36 mm / 1.156 in	3.96 mm / 0.156 in	6.35 mm / 0.250 in	0.076 mm / 0.0030 in	0.038 mm / 0.0015 in
2115013	60.00 mm / 2.362 in	75.00 mm / 2.953 in	29.36 mm / 1.156 in	3.96 mm / 0.156 in	6.35 mm / 0.250 in	0.076 mm / 0.0030 in	0.038 mm / 0.0015 in
2115030	75.00 mm / 2.953 in	90.00 mm / 3.534 in	29.36 mm / 1.156 in	3.96 mm / 0.156 in	6.35 mm / 0.250 in	0.076 mm / 0.0030 in	0.038 mm / 0.0015 in
2115031	90.00 mm / 3.534 in	100.00 mm / 3.937 in	29.36 mm / 1.156 in	3.96 mm / 0.156 in	6.35 mm / 0.250 in	0.076 mm / 0.0030 in	0.038 mm / 0.0015 in
2115032	100.00 mm / 3.9	115.00 mm / 4.528 in	29.36 mm / 1.156 in	3.96 mm / 0.156 in	6.35 mm / 0.250 in	0.076 mm / 0.0030 in	0.038 mm / 0.0015 in

* If a guide sleeve or stop collar is used, minimum hole length can be as small as 1.78 mm / 0.070 in for holes larger than 6.30 mm / 0.248 in.
Note: A handle 152 mm / 6 in long and 33.3 mm / 1.31 in diameter is supplied with plugs over 75.0 mm / 2.953 in.

Through hole plugs

(DP10 and DP5)

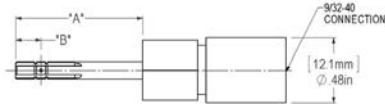

1.57 mm - 6.35 mm / 0.062 in - 0.25 in
Minimum recommended for hole length: 3.18 mm / 0.125 in

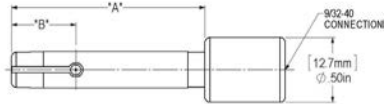

6.35 mm - 9.49 mm / 0.250 in - 0.3735 in
Minimum recommended for hole length: 3.18 mm / 0.125 in
With guide sleeve or stop collar: 1.14 mm / 0.045 in

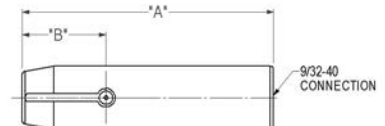

9.49 mm - 11.10 mm / 0.3735 in - 0.437 in
Minimum recommended for hole length: 3.18 mm / 0.125 in
With guide sleeve or stop collar: 1.14 mm / 0.045 in
May be used with AHA-23 or -24 extensions for deep holes.



11.10- mm - 19.05 mm / 0.437 in - 0.750 in
Minimum recommended for hole length: 3.18 mm / 0.125 in
with proper support min. is 1.14 mm / 0.045 in
May be used with AHA-23 or -24 extensions for deep holes.

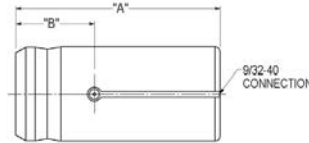

19.05 mm - 44.45 mm / 0.750 in - 1.750 in
Minimum recommended for hole length: 3.18 mm / 0.125 in
With guide sleeve or stop collar: 1.14 mm / 0.04 in
May be used with AHA-23 or -24 extensions for deep holes.

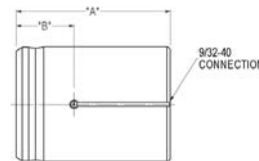

44.45 mm - 76.45 mm / 1.750 in - 3.010 in
Minimum recommended for hole length: 3.18 mm / 0.125 in
With guide sleeve or stop collar: 1.14 mm / 0.04 in
May be used with AHA-23 or -24 extensions for deep holes.

Above	To and Include	"A" Overall Length	"B" Jet Centerline	Minimum Hole Length*	Measuring Range DP10	Measuring Range DP5
1.57 mm / 0.062 in	6.35 mm / 0.250 in	23.81 mm / 0.938 in	4.76 mm / 0.188 in	3.18 mm / 0.125 in	0.015 mm / 0.0006 in	0.008 mm / 0.0003 in
6.35 mm / 0.250 in	9.49 mm / 0.3735 in	38.10 mm / 1.500 in	12.70 mm / 0.500 in	3.18 mm / 0.125 in	0.015 mm / 0.0006 in	0.008 mm / 0.0003 in
9.49 mm / 0.3735 in	11.10 mm / 0.437 in	41.28 mm / 1.625 in	15.88 mm / 0.625 in	3.18 mm / 0.125 in	0.015 mm / 0.0006 in	0.008 mm / 0.0003 in
11.10 mm / 0.437 in	19.05 mm / 0.750 in	41.28 mm / 1.625 in	15.88 mm / 0.625 in	3.18 mm / 0.125 in	0.015 mm / 0.0006 in	0.008 mm / 0.0003 in
19.05 mm / 0.750 in	44.45 mm / 1.750 in	41.28 mm / 1.625 in	15.88 mm / 0.625 in	3.18 mm / 0.125 in	0.015 mm / 0.0006 in	0.008 mm / 0.0003 in
44.45 mm / 1.750 in	76.45 mm / 3.010 in	50.80 mm / 2.000 in	15.88 mm / 0.625 in	3.18 mm / 0.125 in	0.015 mm / 0.0006 in	0.008 mm / 0.0003 in

Blind hole plug

(DP10 and DP5)

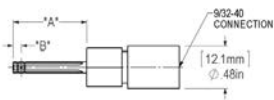

3.18 mm - 6.35 mm / 0.125 in - 0.250 in
Minimum recommended for hole length:
3.96 mm / 0.156 in

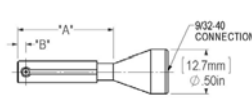

6.35 mm - 11.10 mm / 0.250 in - 0.437 in
Minimum recommended for hole length:
3.18 mm / 0.125 in

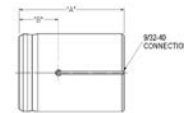

11.10 mm - 76.45 mm / 0.437 in - 3.010 in
Minimum recommended for hole length:
3.18 mm / 0.125 in
Use AHA-23 or -24 extensions for deep hole applications.

Above	To and Include	"A" Overall Length	"B" Jet Centerline	Minimum Hole Length*	Measuring Range DP10	Measuring Range DP5
3.18 mm / 0.125 in	6.35 mm / 0.250 in	21.44 mm / 0.844 in	2.39 mm / 0.094 in	3.96 mm / 0.156 in	0.015 mm / 0.0006 in	0.008 mm / 0.0003 in
6.35 mm / 0.250 in	11.10 mm / 0.437 in	27.79 mm / 1.094 in	2.39 mm / 0.094 in	3.05 / 0.120 in	0.015 mm / 0.0006 in	0.008 mm / 0.0003 in
11.10 mm / 0.437 in	76.45 mm / 3.010 in	27.79 mm / 1.094 in	2.39 mm / 0.094 in	3.05 / 0.120 in	0.015 mm / 0.0006 in	0.008 mm / 0.0003 in

* If a guide sleeve or stop collar is used, minimum hole length can be as small as 1.1 mm / 0.045 in for holes larger than 6.4 mm / 0.250 in.

Super blind plugs

Blind hole air plugs can be furnished to check shorter holes than listed above, and can be furnished to check closer to the bottom of a hole. Holes must be at least 1.9 mm / 0.075 in long, and the distance from the end of the plug to the center-line of the jets can be as short as 1.4 mm / 0.055 in for plugs below 6.4 mm / 0.250 in or 1.1 mm / 0.045 in for plugs above 6.4 mm / 0.250 in.

Air snaps for in process gaging

For precision turning or grinding of parts it may be critical to measure the OD lands while the part is still in place on the machine while mounted in a chuck or on centers. Since side clearances can present gaging problems with crankshaft diameters or similar applications, Mahr designed a new line of Air Snaps that make the tough measurements easier and affordable. We based our new Air Snap design on our own proven air tooling techniques, known for providing long life and high-resolution in tough shop environments.

Air snaps are available in standard sizes from 12.5 mm / 0.49 in through 184 mm / 7.25 in using 2500/5000 systems. Widths are typically 19 mm / 0.75 in but can be customized to reach diameters having tight clearances.

Options for air snaps

As with air plugs or air ring, jets can be located central in the snap or positioned close to either side for exploring close to a shoulder. Special designs can incorporate stops built into the air snap to act as a locator to ensure that the measuring circuit is precisely at the land called out on the part print. Multiple circuit Air Snaps are available for speeding the process while checking the journal for size variation, taper, barrel or hourglass shape. For large diameters, the body of the snap is lightened for easier use. For precision ground parts gardur bumpers may be employed to protect highly polished finishes.

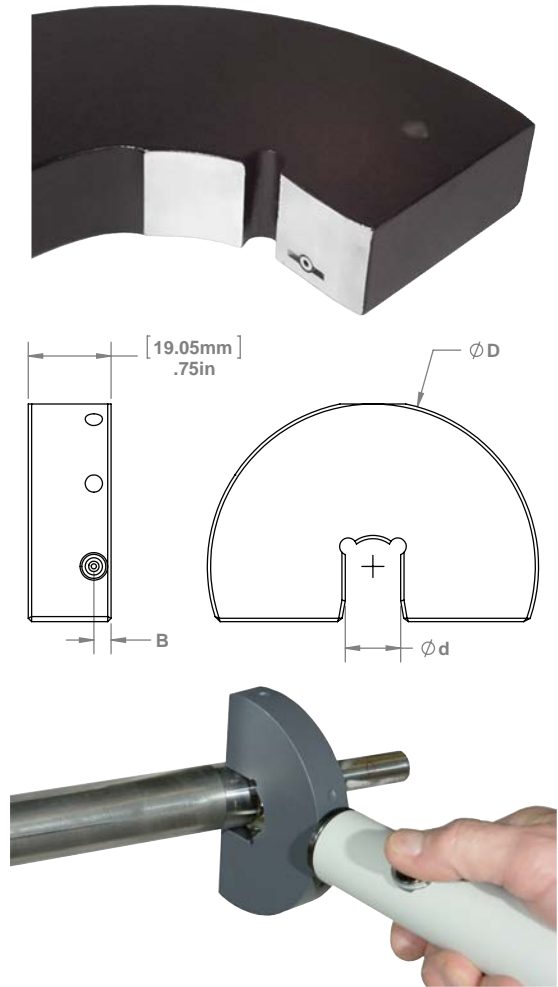

Order No. Through	Order No. Blind	"D" Outside Diameter	"B" Blind Jet Centerline	"B" Through Jet Centerline	Nominal Size Above	To and Include
2115040	2115046	76.2 mm / 3.00 in	3.97 mm / 0.156 in	9.525 mm / 0.375 in	12.7 mm / 0.5 in	25.4 mm / 1.00 in
2115041	2115047	101.6 mm / 4.00 in	3.97 mm / 0.156 in	9.525 mm / 0.375 in	25.4 mm / 1.00 in	44.45 mm / 1.75 in
2115042	2115048	127 mm / 5.00 in	3.97 mm / 0.156 in	9.525 mm / 0.375 in	44.45 mm / 1.75 in	69.85 mm / 2.75 in
2115043	2115049	152.4 mm / 6.00 in	3.97 mm / 0.156 in	9.525 mm / 0.375 in	69.85 mm / 2.75 in	95.25 mm / 3.75 in
2115044	2115050	177.8 mm / 7.00 in	3.97 mm / 0.156 in	9.525 mm / 0.375 in	95.25 mm / 3.75 in	120.65 mm / 4.75 in
2115045	2115051	203.2 mm / 8.00 in	3.97 mm / 0.156 in	9.525 mm / 0.375 in	120.65 mm / 4.75 in	177.8 mm / 7.00 in



Air rings for outside diameter measurement

As with air plugs, air rings are supplied in several styles for external measuring.

Jetting options

Two and three jet rings are most common, used for checking outside diameters for sizes and round conditions from 6.3 mm / 0.248 in to 50 mm / 2 in. Four and six jet rings are also available for special applications. All air rings high chrome content stainless wear surfaces unless otherwise specified.



Jet locations

Standard location of the jets are at the midpoint of the air ring. However, just like a blind hole air plug, where OD's need to be checked near a shoulder, or where part length is restricted, contact Mahr for technical assistance about shoulder and snout type air rings. When ordering ring gages, please specify the following:

- On existing tooling the item and unique identifier
- Nominal size and tolerance
- Air system the plugs being used with
- Air ring style – Through, shoulder or snout style
- Standard HCC material or optional coating
- It is recommended to purchase master at the same time with its size, class, material and certification

Options for air rings

As with air plugs or air snap, jets can be located central in the ring or positioned close to either side for exploring close to a shoulder at specific requirements determined by the application. Special designs can incorporate stops built into the air ring to act as a locator to ensure that the measuring circuit is precisely at the land called out on the part print. Multiple circuit air rings are available for speeding the process while checking the part for size variation, taper, barrel or hourglass shape. For large diameters custom air rings with lightening holes make the gage easy to use. Air rings can be provided for cylindrical tapers having multiple circuits and provide diameter and taper angle information.

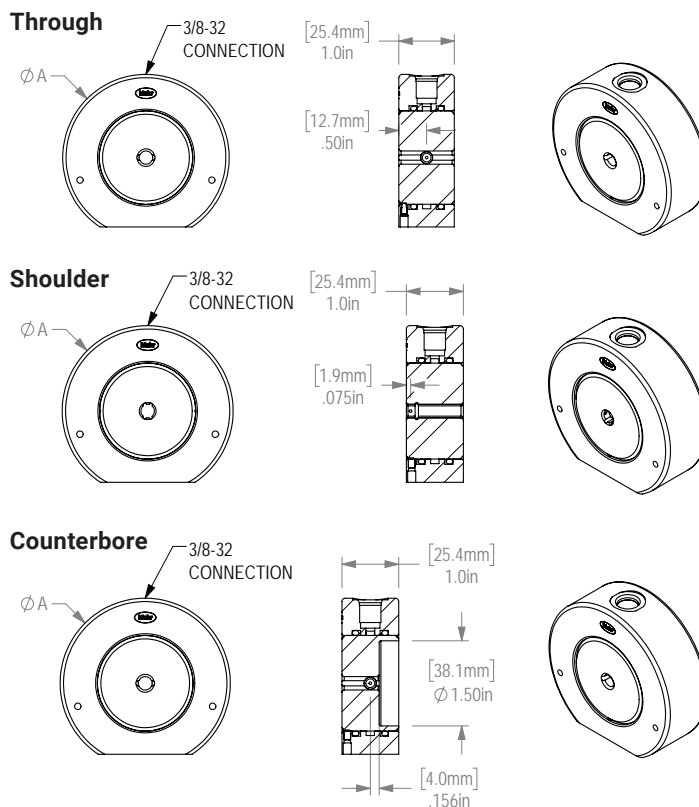

Order No. Through	Order No. Shoulder	Order No. Counterbore	Jets	Above	To and Including	Outside Diameter	Width
2116000	2116010	2116020	2-jet	6.3 mm / 0.248 in	8 mm / 0.315 in	75 mm / 3 in	25.4 mm / 1 in
2116001	2116011	2116021	2-jet	8.0 mm / 0.315 in	21 mm / 0.827 in	75 mm / 3 in	25.4 mm / 1 in
2116002	2116012	2116022	2-jet	21 mm / 0.827 in	25 mm / 0.984 in	75 mm / 3 in	25.4 mm / 1 in
2116003	2116013	2116023	2-jet	25 mm / 0.984 in	44 mm / 1.732 in	100 mm / 4 in	25.4 mm / 1 in
2116004	2116014	2116024	2-jet	44 mm / 1.732 in	50 mm / 1.969 in	100 mm / 4in	25.4 mm / 1 in
2116005	2116015	2116025	3-jet	6.3 mm / 0.248 in	8 mm / 0.315 in	75 mm / 3 in	25.4 mm / 1 in
2116006	2116016	2116026	3-jet	8.0 mm / 0.315 in	21 mm / 0.827 in	75 mm / 3 in	25.4 mm / 1 in
2116007	2116017	2116027	3-jet	21 mm / 0.827 in	25 mm / 0.984 in	75 mm / 3 in	25.4 mm / 1 in
2116008	2116018	2116028	3-jet	25 mm / 0.984 in	44 mm / 1.732 in	100 mm / 4 in	25.4 mm / 1 in
2116009	2116019	2116029	3-jet	44 mm / 1.732 in	50 mm / 1.969 in	100 mm / 4 in	25.4 mm / 1 in

Air rings configuration options

Portable or bench mounted

Depending on the application there are many ways to use and hold an air ring. They may be hand held and placed over the part if the part is still on the machine.

If the OD is larger handles can be incorporated into the ring to make it easier to use or the air ring can be base mounted allowing the part to be brought to the gage. In any of these uses, as with an air plug, all the benefits of air gaging are realized, easy to use with fast precise results. Air rings may be used horizontally or vertically by hand or mounted to a universal base.

For special applications, multiple rings can be mounted to a single base allowing for a sequential part measurement. If the part is thin or has multiple lands to be measured, a movable reference platen or part ejector can be designed into the air ring.

Guide chutes

Guide chutes are available in a host of options to improve the inspection process. Vee type guide chutes can be furnished on one or both sides of an air ring from 6.3 mm / 0.248 in through 44.5 mm / 1.75 in. Other options include tube type guide chutes for sizes 6.3 mm / 0.248 in through 63.5 mm / 2.5 in. Standard length of the guide chutes are 63.5 mm / 2.5 in and affix to the side of the Air Ring. Normal length of the chute is 63.5 mm / 2.5 in. Other options including heavy duty out riggers and universal vee stands can be provided.

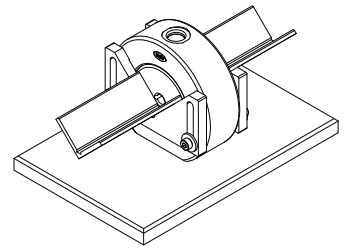
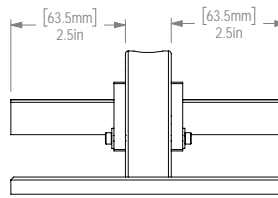

Jet probes are modular and convenient

Jet probes have an open jet at the end built into the cylindrical body thus they act as a non-contact probing element. Jet probes are ideal for measuring flatness of surfaces which cannot be touched, or for building into fixture designs where air gaging is called for.

Jet probes can be used with 2500/5000:1 Millimar air gage displays, and are supplied singly or in matched pairs. Jet probes are supplied with AHO-1 air hose, a zero setting valve, and hardware for mounting to the Dimensionair.

- 9.5 mm / 0.375 in bodies provide standardized mounting configurations.
- Compact size allows easy access to hard-to-reach dimensions
- Jet probes are calibrated for instant use with Millimar 2500/5000 systems - just set zero and measure.
- Available in single-probe and matched-probe configurations



Order No.	Description	Measuring Range
2086612	Jetted air probe with master restrictor valve and hose	±38 μm / ±0.0015 in
2086613	Matched pair of jetted air probes with manifold, master restrictor valve and hose	±38 μm / ±0.0015 in

Accessories for Millimar systems

An air plug should be equipped with an extension and handle to avoid excessive strain on the air connection and corrosion on the polished plug body. Extensions may be combined for gaging deep holes. Selection of a handle and extension is determined by the bore diameter and whether or not it is preceded by a larger C-bored diameter.

Corresponding thread sizes of the handle or extension must also be considered. If no portion of the handle or extension enters the part, only thread sizes must be considered. If the plug does enter the part, then both OD and thread size must be considered.

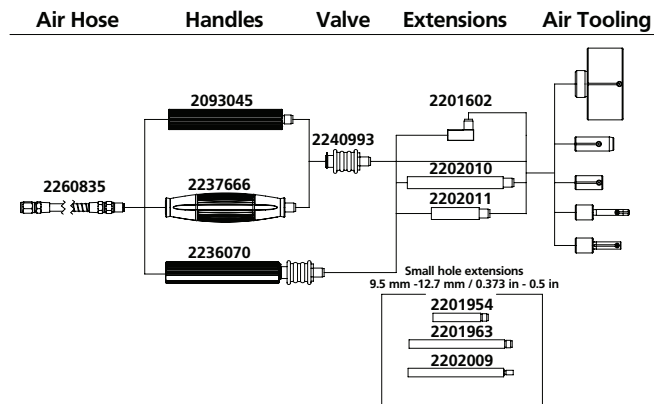

Order No.	Model	Description	Thread	OD	Length	Notes	Tooling ID
2202010	AHA-4	Extension	3/8-32	12.07 mm / 0.475 in	102 mm / 4 in	Accept 2500/5000 hose / plug sizes up to 76.30 mm / 3.004 in	50/20
2202011	AHA-5	Extension	3/8-32	12.07 mm / 0.475 in	51 mm / 2 in		50/20
2201954	AEX-1	Extension	5/16-32	9.02 mm / 0.355 in	51 mm / 2 in	Used with air plugs from 9.47 mm / 0.3735 in to 14.93 mm / 0.588 in and adaptor 2201601	50/20
2201963	AEX-2	Extension	5/16-32	9.02 mm / 0.355 in	102 mm / 4 in		50/20
2202009	AHA-28	Extension	10-32	9.14 mm / 0.360 in	102 mm / 4 in	Used with air plugs from 9.47 mm / 0.3735 in to 11.8 mm / 0.467 in and adaptor 2201588	50/20
2237666		Handle	3/8-32		127 mm / 5 in	Ergonomic, black	50/20
2093045	AHA-66	Handle	3/8-32		122 mm / 4.75 in	Aluminum extrusion handle	50/20
2236070		Handle	3/8-32			Aluminum extrusion handle with shut of valve	50/20
2202003		Handle				Replacement aluminum handle for air tooling over 76.3 mm / 3 in	50/20
2240993		Valve	3/8-32			Sliding shut off valve	50/20
2202007	AHA-23	Extension	9/32-40	9.14 mm / 0.360 in	51 mm / 2 in		10/5
2202008	AHA-24	Extension	9/32-40	9.14 mm / 0.360 in	102 mm / 4 in		10/2
2236071		Handle	9/32-40			Aluminum extrusion handle with shut of valve	10/5

Hoses

Mahr's new hose kits allow the user to adapt the hose length to any application. Use with any 2500/5000 system, the existing threaded adaptor while allowing for quick disconnect, or the shoes on tooling with barb connectors.

Filters

Good air gaging practice requires a clean and dry air supply. Shop air often contains water and oil which must be removed. Mahr offers a robust filter designed to remove much of the air contamination before it enters the display and tooling. In extreme cases a second filter/water separator may be required.

Order No.	Description	Replaces	Thread	Magnification
2260835	Kit, air hose assembly 2 M / 6 ft	AHO-1, AHO-8, AHO-10	3/8-32	2500/5000
2261280	Kit, air hose assembly 4 M / 13 ft	SHO-26	3/8-32	2500/5000
2261278	Kit, air hose assembly 4 M / 13 ft	AHS-5060	3/8-32	2500/5000
2202077	Hose, adaptor assy, 3 ft	AHO-20	9/32-40	10,000/20,000
2203027-E	O-ring for 2,500 / 5,000	ARG-1		
2203070	O-ring for 10,000 / 20,000	ARG-6		
2203028-E	O-ring for AEX-1, AEX-2 and AHA-28	ARG-10		

Order No.	Description	Comment
2262714	Filter assembly (2262712) with mounting brackets and 7/16-20 flare fittings	Replaces AFL-24 2201994
2262710	Filter element for 2262714 filter/trap	
2258471	Supply kit for 3 PtoE modules, used with Cockpit / C 1202	
2238020	Supply kit for µDimensionair	

Air display calibration / magnification kits

Magnification kits provide a means for checking amplifier accuracy, traceable to the National Institute of Standards and Technology (NIST). Each kit contains restrictors that provide pressure characteristics at zero and at both ends of the scale.

Order No.	Model	For Use With	Tool ID
2094182		1260:1	60
2086960	AMR-12	2500:1	50
2086961	AMR-13	5000:1	20
2086962	AMR-14	10000:1	10
2086963	AMR-15	20000:1	5



2086962

Manifolds

Manifolds allow connecting multiple pieces of air tooling to one Dimensionair. Toggle valves allow activation of the selected tool. Manifolds are compatible with Millimar display systems 2500/5000. For best performance always remaster when changing tools.

Order No.	Manifolds
2248282	2-way
2248283	3-way
2248284	4-way
2248285	5-way



2248283

Adaptors for competitive air tooling

With the flexibility of the Mahr Millimar C 1202 display and N 1700 gaging computer, Mahr offers an easy way to use existing tooling with these feature packed products. In effect getting more information from available tooling. Whether it be two master tooling or Mahr single master equivalent, there are adaptors available to bring the tooling within the operation range of the Mahr system.

Order No.	Model	Thread	Notes
2086610 2201515 *	AAD-313 AAD-194	10-32M to 3/2-32F	Adaptor for tooling 2.7686 mm / 0.109 in to 12.547 mm / 0.494 in
2201586 2201514*	AAD-312 AAD-193	1/4-28M to 3/8-32F	Adaptor for tooling 12.547 mm / 0.494 in to 23.876 mm / 0.940 in
2201587 2201516*	AAD-314 AAD-195	1/2-20M to 3/8-32F	Adaptor for tooling 23.876 mm / 0.940 in to 139.7 mm / 5.500 in
2086610	AAD-313	10-32M to 3/8-32F	Adaptor for tooling 2.7686 mm / 0.109 in to 12.547 mm / 0.494 in
2242767 2263135*		1/8 barb to 3/8-32F	Adaptor
2242777		Setlock/Moore to 3/8-32F	Adaptor
AAD-175	AAD-175	3/8-32 F, 1/8 NPT F, 1.25 in LG, 9/16 HEX	Adaptor
AAD-77	AAD-77	3/8-32 F, 1/4 NPT M,	Adaptor
AAD-200	AAD-200	3/8-32 F, 9/32-40 F, 1 1/4 in LG,	Adaptor
AAD-201	AAD-201	3/8-32 M, both ends	

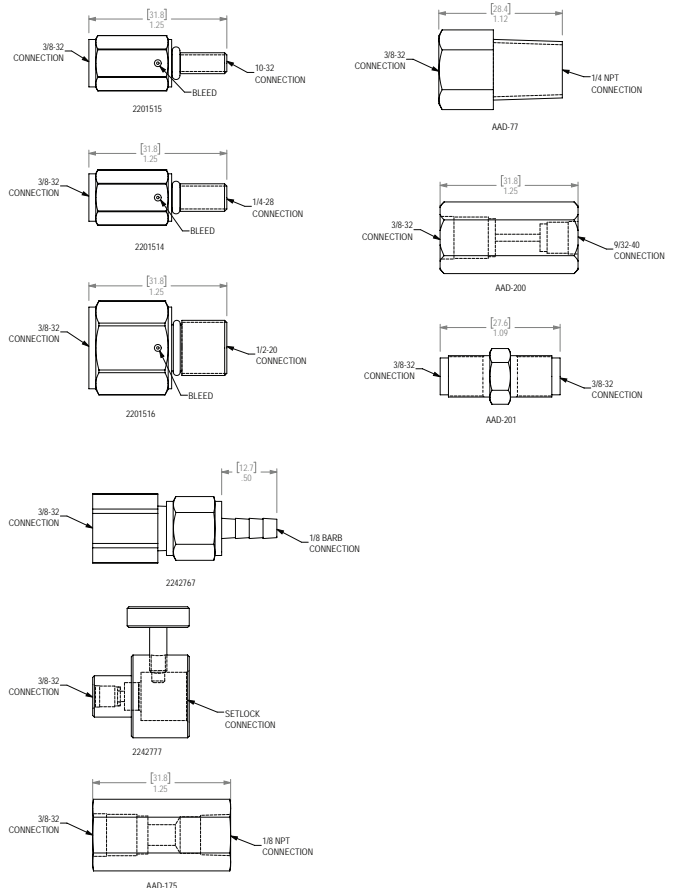

Note: *Includes bleed for small jets to simulate Mahr

AGD master setting rings, discs, and plugs

Master rings

- Traceable certification and calibration available on request
- Stabilized and hardened
- 100% usable grinding surface
- Ends ground square
- Lapped finish

Master plugs

- Traceable certification and calibration available on request
- Stabilized and hardened
- 100% usable grinding surface
- Ends ground square
- Lapped finish

Master discs AGD style 3

- Traceable certification and calibration available on request
- Lapped to size and polished
- Non-gaging areas black oxidized - ring faces ground
- Meet all requirements of ANSI Specification B47.1-1988
- Manufactured in accordance with ANSI Specification B89.1.5
- Furnished with clear insulators
- All dimensions are AGD style 3Notes:

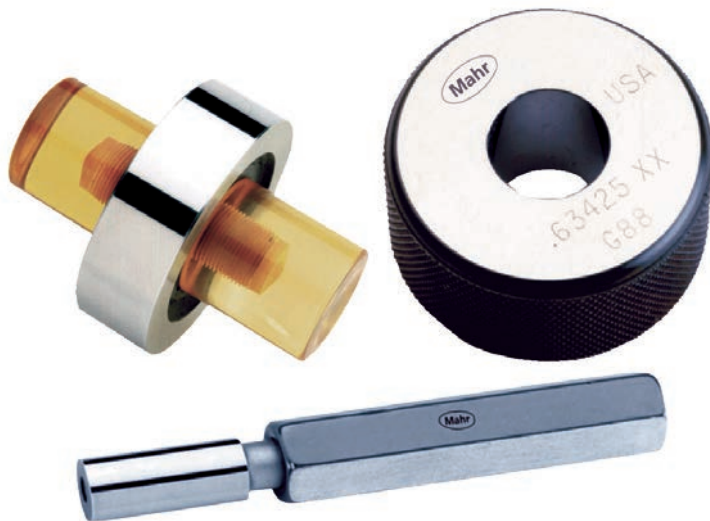

Classes and Tolerances

Size Range of Work Above	Size Range of Work To and Including	Tolerance of Master Class XXX	Tolerance of Master Class XX	Tolerance of Master Class X
2.67 mm / 0.105 in	20.96 mm / 0.825 in	0.25 µm / 10 µin	0.51 µm / 20 µin	1.02 µm / 40 µin
20.96 mm / 0.825	38.35 mm / 1.51 in	0.38 µm / 15 µin	0.76 µm / 30 µin	1.52 µm / 60 µin
38.45 mm / 1.51 in	63.75 mm / 2.51 in		1.02 µm / 40 µin	2.03 µm / 80 µin
63.75 mm / 2.51 in	4.51 in		1.27 µm / 50 µin	2.54 µm / 100 µin
4.51 in	6.51 in		1.65 µm / 65 µin	3.3 µm / 130 µin
6.51 in	8.51 in		2.03 µm / 80 µin	4.06 µm / 160 µin

Notes:

- Master plugs and discs are furnished in hardened steel, either plain or chrome plated. They are made in Class XX and X for air gage applications. Discs are also available in Class Y.
- Tolerances are divided equally plus and minus from the required size unless otherwise specified. Plug and disc certification supplied on request.
- If air rings 1.5 in and smaller are equipped with guide chutes, A.G.D. Style 3 discs are required.

Master setting rings AGD

Master rings are used to set the nominal dimension for most air plugs. Mahr manufactures and certifies these master rings in our Precision Measurement Center. Certified with some of the lowest uncertainties means you are getting the most trusted masters available. DIN master rings can be offered upon request

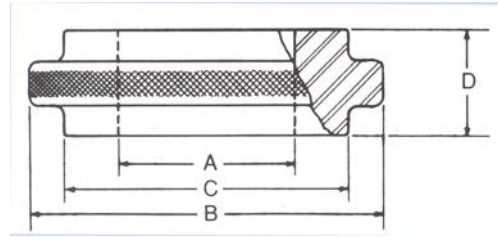

Order No. Class XXX	Order No. Class XX	Order No. Class X	Order No. Class Y or Z	Size Range Above	Size Range Through and Including	B	C	D
	2093058	2093080	2093102	1.6 mm / 0.062 in	1.8 mm / 0.070 in	22.83 mm / 0.938 in		6.35 mm / 0.25 in
	2093059	2093081	2093103	1.8 mm / 0.070 in	2.5 mm / 0.100 in	22.83 mm / 0.938 in		6.35 mm / 0.25 in
2093049	2093060	2093082	2093104	2.5 mm / 0.100 in	3.2 mm / 0.125 in	22.83 mm / 0.938 in		6.35 mm / 0.25 in
2093050	2093061	2093083	2093105	3.2 mm / 0.125 in	3.8 mm / 0.150 in	22.83 mm / 0.938 in		6.35 mm / 0.25 in
2093051	2093062	2093084	2093106	3.8 mm / 0.150 in	4.7 mm / 0.185 in	22.83 mm / 0.938 in		9.53 mm / 0.375 in
2093052	2093063	2093085	2093107	4.7 mm / 0.185 in	6.1 mm / 0.240 in	22.83 mm / 0.938 in		9.53 mm / 0.375 in
2093053	2093064	2093086	2093108	6.1 mm / 0.240 in	9.3 mm / 0.365 in	22.83 mm / 0.938 in		9.53 mm / 0.375 in
2093054	2093065	2093087	2093109	9.3 mm / 0.365 in	13.0 mm / 0.510 in	34.93 mm / 1.375 in		19.05 mm / 0.75 in
2093055	2093066	2093088	2093110	13.0 mm / 0.510 in	21.0 mm / 0.825 in	44.45 mm / 1.75 in		23.83 mm / 0.938 in
2093056	2093067	2093089	2093111	21.0 mm / 0.825 in	28.8 mm / 1.135 in	53.98 mm / 2.125 in		28.58 mm / 1.125 in
2093057	2093068	2093090	2093112	28.8 mm / 1.135 in	38.4 mm / 1.510 in	63.5 mm / 2.5 in		33.35 mm / 1.313 in
	2093069	2093091	2093113	38.4 mm / 1.510 in	51.1 mm / 2.010 in	102 mm / 4 in	73 mm / 2.875 in	38.1 mm / 1.5 in
	2093070	2093092	2093114	51.1 mm / 2.010 in	63.8 mm / 2.510 in	114.3 mm / 4.5 in	85.7 mm / 3.375 in	38.1 mm / 1.5 in
	2093071	2093093	2093115	63.8 mm / 2.510 in	76.5 mm / 3.010 in	127 mm / 5 in	101.6 mm / 4 in	38.1 mm / 1.5 in
	2093072	2093094	2093116	76.5 mm / 3.010 in	89.2 mm / 3.510 in	139.7 mm / 5.5 in	114.3 mm / 4.5 in	38.1 mm / 1.5 in
	2093073	2093095	2093117	89.2 mm / 3.510 in	101.9 mm / 4.010 in	161.93 mm / 6.375 in	130.2 mm / 5.125 in	38.1 mm / 1.5 in
	2093074	2093096	2093118	101.9 mm / 4.010 in	120.9 mm / 4.760 in	181.15 mm / 7.25 in	149.2 mm / 5.875 in	38.1 mm / 1.5 in
	2093075	2093097	2093119	120.9 mm / 4.760 in	140.0 mm / 5.510 in	209.5 mm / 8.25 in	138.3 mm / 6.625 in	38.1 mm / 1.5 in
	2093076			140.0 mm / 5.510 in	159.0 mm / 6.260 in	234 mm / 9.25	187.3 mm / 7.375 in	38.1 mm / 1.5 in
	2093077			159.0 mm / 6.260 in	178.1 mm / 7.010 in	260.35 mm / 10.25 in	206.4 mm / 8.125 in	38.1 mm / 1.5 in
	2093078			178.1 mm / 7.010 in	197.1 mm / 7.760 in	285.75 mm / 11.25 in	225.4 mm / 8.875 in	38.1 mm / 1.5 in
	2093079			197.1 mm / 7.760 in	216.2 mm / 8.510 in	311.15 mm / 12.25 in	244.5 mm / 9.625 in	38.1 mm / 1.5 in

Master setting plugs - hardened steel

Master setting plugs are used to set the nominal dimension on small or blind style air rings. Mahr manufactures and certifies these master plugs in our Precision Measurement Center. Certified with some of the lowest uncertainties means you are getting the most trusted masters available.

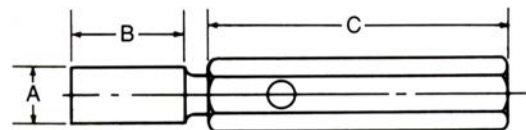

Order No. Class XX	Order No. Class X	Order No. Class Y or Z	Size Range Above	Size Range Through and Including	DC	B	C
Taper Lock Type with Handle							
2093190	2093208	2093226	6.1 mm / 0.240 in	9.3 mm / 0.365 in	G13001	19.5 mm / 0.75 in	69.85 mm
2093191	2093209	2093227	9.3 mm / 0.365 in	13.0 mm / 0.510 in	G13001	25.4 mm / 1 in	76.2 mm
Taper Lock Type with Handle							
2093192	2093210	2093228	13.0 mm / 0.510 in	21.0 mm / 0.825 in	G13001	31.75 mm / 1.25 in	82.55 mm
2093193	2093211	2093229	21.0 mm / 0.825 in	28.8 mm / 1.135 in	G13001	34.93 mm / 1.375 in	92.08 mm
2093194	2093212	2093230	28.8 mm / 1.135 in	38.4 mm / 1.510 in	G13001	38.1 mm / 1.5 in	102 mm

Master setting plugs - hardened steel

Order No. Class XX	Order No. Class X	Order No. Class Y or Z	Size Range Above	Size Range Through and Including	DC	B	C
Tri-Lock Type with Handle							
2093195	2093213	2093231	38.4 mm / 1.510 in	51.1 mm / 2.010 in	G13001	47.63 mm / 1.875 in	127 mm / 5 in
2093196	2093214	2093232	51.1 mm / 2.010 in	63.8 mm / 2.510 in	G13001	50.8 mm / 2 in	127 mm / 5 in
2093197	2093215	2093233	63.8 mm / 2.510 in	76.5 mm / 3.010 in	G13001	53.98 mm / 2.125 in	152.4 mm / 6 in
2093198	2093216	2093234	76.5 mm / 3.010 in	89.2 mm / 3.510 in	G13001	53.98 mm / 2.125 in	152.4 mm / 6 in
2093199	2093217	2093235	89.2 mm / 3.510 in	101.9 mm / 4.010 in	G13001	53.98 mm / 2.125 in	152.4 mm / 6 in
2093200	2093218	2093236	101.9 mm / 4.010 in	114.3 mm / 4.510 in	G13001	53.98 mm / 2.125 in	152.4 mm / 6 in
2093201	2093219	2093237	114.3 mm / 4.510 in	127.3 mm / 5.010 in	G13001	53.98 mm / 2.125 in	152.4 mm / 6 in
2093202	2093220	2093238	127.3 mm / 5.010 in	140.0 mm / 5.510 in	G13001	53.98 mm / 2.125 in	152.4 mm / 6 in
2093203	2093221	2093239	140.0 mm / 5.510 in	152.7 mm / 6.010 in	G13001	53.98 mm / 2.125 in	152.4 mm / 6 in
2093204	2093222	2093240	152.7 mm / 6.010 in	165.4 mm / 6.510 in	G13001	53.98 mm / 2.125 in	152.4 mm / 6 in

Custom part masters

Custom part masters are used as a standard for many Engineered Solutions Gages. Almost every dedicated variable gage in use has at least one custom master associated with it. Typically these masters are used on shop floor inspection equipment as artifacts that reference the equipment. Some common examples include rotors, connecting rods, pistons, special tapers, cylinder liners, hydraulic and pump housings.



All masters are made of tool steel, hardened and double stabilized. Chrome plate is also available. In cases where the gage might be used in a corrosive environment, 440-C Stainless Steel may be used. Certain tight manufacturing tolerance applications may need min., mean and max. condition masters for greater accuracy when setting the gage fixture.

Master setting discs AGD

Master setting discs are used to set the nominal dimension through style air rings or air snaps. Mahr manufactures and certifies these master discs in our Precision Measurement Center. Certified with some of the lowest uncertainties means you are getting the most trusted masters available.

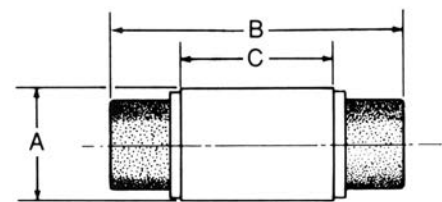

Order No. Class XX	Above	Through and Including	"B"	"C"
2093250	3.8 mm / 0.150 in		41.28 mm / 1.625 in	11.25 mm / 0.438 in
2093251	6.1 mm / 0.240 in		42.88 mm / 1.688 in	12.70 mm / 0.500 in
2093252	9.3 mm / 0.365 in		47.63 mm / 1.875 in	14.30 mm / 0.563 in
2093253	13.0 mm / 0.510 in		49.23 mm / 1.938 in	15.88 mm / 0.625 in
2093254	21.0 mm / 0.825 in		57.15 mm / 2.250 in	17.48 mm / 0.688 in
2093255	28.8 mm / 1.135 in		60.33 mm / 2.375 in	22.17 mm / 0.813 in
2093256	38.4 mm / 1.510 in		60.33 mm / 2.375 in	22.23 mm / 0.8758 in
2093257	51.1 mm / 2.010 in		60.33 mm / 2.375 in	22.23 mm / 0.8758 in
2093258	63.8 mm / 2.510 in		85.73 mm / 3.375 in	25.40 mm / 1 in
2093259	76.5 mm / 3.010 in		85.73 mm / 3.375 in	25.40 mm / 1 in
2093260	89.2 mm / 3.510 in		85.73 mm / 3.375 in	25.40 mm / 1 in
2093261	101.9 mm / 4.010 in		85.73 mm / 3.375 in	25.40 mm / 1 in
2093262	114.3 mm / 4.510 in		85.73 mm / 3.375 in	25.40 mm / 1 in
2093263	127.3 mm / 5.010 in		85.73 mm / 3.375 in	25.40 mm / 1 in
2093264	140.0 mm / 5.510 in		85.73 mm / 3.375 in	25.40 mm / 1 in
2093265	152.7 mm / 6.010 in		85.73 mm / 3.375 in	25.40 mm / 1 in
2093266	165.4 mm / 6.510 in		85.73 mm / 3.375 in	25.40 mm / 1 in
2093267	178.1 mm / 7.010 in		85.73 mm / 3.375 in	25.40 mm / 1 in
2093268	190.8 mm / 7.510 in	203.5 mm / 8.010 in	85.73 mm / 3.375 in	25.40 mm / 1 in

Standards - setting rings

6105 N / 6107 S, DIN Type B

Millimar 6105 setting rings for jet air gage plugs and contact gage plugs have been carefully hardened, aged, ground and lapped.

- Quality: N
- Manufacturing tolerance : JS3
- Cylinder form tolerance : 0.4 x numerical value of IT4
- Provided with certification VDI/VDE/DGO 2618 Scope 2

Millimar 6107 setting rings for jet air gage plugs have been carefully hardened, aged, ground and lapped.

- Quality: S
- Manufacturing tolerance : JS3
- Cylinder form tolerance: 0.1 x numerical value of IT4
- Measuring uncertainty of the labeled nominal value: 0.5 x numerical value of IT1
- Provided with certification VDI/VDE/DGO 2618 Scope 2



Setting Rings 6105 N

Order No.	From	To and Including
2105300	2 mm	3 mm
2105301	3 mm	4 mm
2105302	4 mm	6 mm
2105303	6 mm	7 mm
2105304	7 mm	10 mm
2105305	10 mm	11 mm
2105306	11 mm	18 mm
2105307	18 mm	21 mm
2105308	21 mm	28 mm
2105309	28 mm	32 mm
2105310	32 mm	40 mm
2105311	40 mm	47 mm
2105312	47 mm	50 mm
2105313	50 mm	55 mm
2105314	55 mm	58 mm
2105315	58 mm	60 mm

Order No.	From	To and Including
2105316	60 mm	65 mm
2105317	65 mm	68 mm
2105318	68 mm	70 mm
2105319	70 mm	72 mm
2105320	72 mm	75 mm
2105321	75 mm	78 mm
2105322	78 mm	80 mm
2105323	80 mm	82 mm
2105324	82 mm	85 mm
2105325	85 mm	88 mm
2105326	88 mm	90 mm
2105327	90 mm	92 mm
2105328	92 mm	95 mm
2105329	95 mm	98 mm
2105330	98 mm	100 mm
2105331	100 mm	105 mm

Order No.	From	To and Including
2105332	105 mm	110 mm
2105333	110 mm	115 mm
2105334	115 mm	120 mm
2105335	120 mm	125 mm
2105336	125 mm	130 mm
2105337	130 mm	135 mm
2105338	135 mm	140 mm
2105339	140 mm	145 mm
2105340	145 mm	150 mm
2105341	150 mm	155 mm
2105342	155 mm	160 mm
2105343	160 mm	165 mm
2105344	165 mm	170 mm
2105345	170 mm	175 mm
2105346	175 mm	180 mm
2105347	180 mm	185 mm

Setting Rings 6107 S

Order No.	From	To and Including
2105400	3 mm	4 mm
2105401	4 mm	6 mm
2105402	6 mm	8 mm
2105403	8 mm	10 mm
2105404	10 mm	18 mm
2105405	18 mm	23 mm
2105406	23 mm	24 mm
2105407	24 mm	25 mm
2105408	25 mm	26 mm
2105409	26 mm	27 mm
2105410	27 mm	28 mm
2105411	28 mm	30 mm
2105412	30 mm	32 mm
2105413	32 mm	34 mm
2105314	55 mm	58 mm
2105315	58 mm	60 mm

Order No.	From	To and Including
2105414	34 mm	37 mm
2105415	37 mm	42 mm
2105416	42 mm	44 mm
2105417	44 mm	45 mm
2105418	45 mm	46 mm
2105419	46 mm	48 mm
2105420	48 mm	50 mm
2105421	50 mm	52 mm
2105422	52 mm	55 mm
2105423	58 mm	55 mm
2105424	60 mm	58 mm
2105425	62 mm	60 mm
2105426	65 mm	62 mm
2105427	68 mm	65 mm
2105330	98 mm	100 mm
2105331	100 mm	105 mm

Order No.	From	To and Including
2105428	68 mm	70 mm
2105429	70 mm	72 mm
2105430	72 mm	75 mm
2105431	75 mm	78 mm
2105432	78 mm	80 mm
2105433	80 mm	82 mm
2105434	82 mm	85 mm
2105435	85 mm	88 mm
2105436	88 mm	90 mm
2105437	90 mm	92 mm
2105438	92 mm	95 mm
2105439	95 mm	98 mm
2105440	98 mm	100 mm
2105441	100 mm	102 mm
2105346	175 mm	180 mm
2105347	180 mm	185 mm

Air gages application examples

Mahr has been solving tight tolerances and complex gaging requirements with air gaging for over 75 years. In that time we have designed thousands of proven designs that provide high precision measurement results.

Whether it be the smallest of parts or large complex parts, there is probably a proven solution within our design files. If it can be done with air gaging, Mahr certainly has the experience to be applied to your application.

Here are but a few of unique solutions which may help address your needs.



Air tooling for ID and OD tapers — angle, size and side straightness



3-circuit air plug for gap width 400 mm deep



Partial diameter air tooling for half bearing measurement



Air gaging for width and depth



Multi-circuit air plug for zenith pumps



Air plug mounted to air compliance device for robot loaded automation



Tapered snap



Air plug for slot width

Air gaging solutions

Air gaging does much more than ID's and OD's. Air tooling can be engineered for many dimensional and form applications for point of manufacture assurance. When gaging requirements challenge your capabilities check with Mahr as we have the experience as seen here with these solutions to provide the high performance gaging you require.

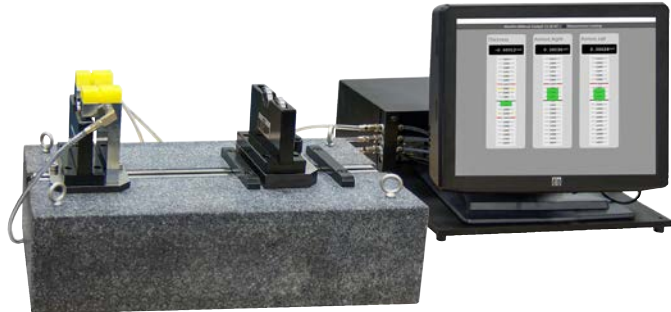

Differential air gaging

Clearances on hydraulic valves and pumps today are measured in microns and it is critical to ensure the match is correct for proper valve operation. When an air ring and plug are combined with a differential amplifier the operator can quickly measure both the ID and OD of the parts and read directly the clearance between the two. This combination allows for matching the two components together as a pair or creates a method for fast sorting of parts for later use. Options exist for computerized solutions where part programs are created for the tooling which allows for fast switchover for different parts and data tracking of the matched pairs for documentation of the match.



Air gaging for camshaft ends face run-out

Air gaging built into dedicated shop floor gages provides high performance and trouble free solutions. Camshafts have critical relationships between the axis of rotation and the end faces in order to create noise-free operation and extend the life of the camshaft.

This custom solution consists of a gaging computer that measured three critical features: the thrust face thickness, variations of the thrust face and the run-out of the thrust face to the bearing journals of the camshaft.

Tolerances were in the order of 0.015 mm / 0.0006 in and gage GR&R performance was to automotive requirements. The gaging computer provided three A/E transducers to read each feature and combine them for the desired results. The gaging computer provided for means to shut off air automatically when not in use, provide easy mastering and data collection to document the results and use for process control

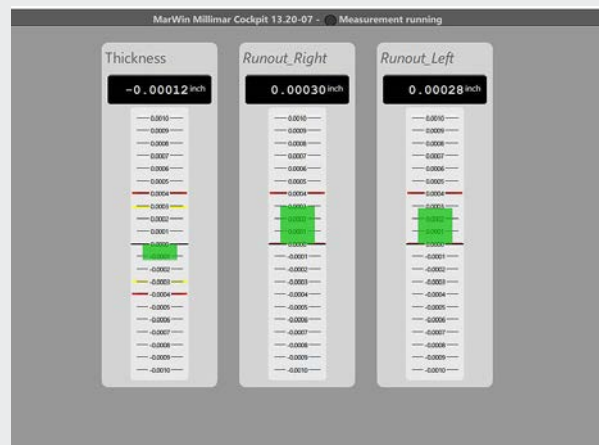

Measuring deep holes with air plugs

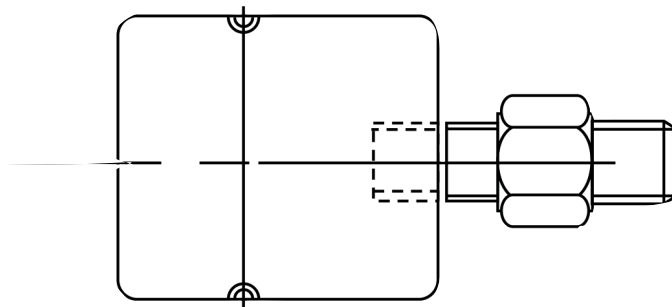

Relieved air plugs

Normally when using an air plug in a deep hole, extensions are combined with the plug to reach the bottom of the bore. When only the "A" length dimensions need to be held to air plug clearances, several options exist, depending on the size of the hole being measured:

Small: 4.75 mm / 0.187 in to 9.4 mm / 0.370 in (through hole plugs) and 4.75 mm / 0.187 in to 11.86 mm / 0.467 in (blind hole plugs). Plugs are provided as a solid piece, with the "A" dimensions held to air plug clearances, and the remainder machined to a slightly smaller diameter.



Larger bores: both through hole and blind hole plugs larger than 9.53 mm / 0.375 in have no shoulder to prevent deep hole gaging, and require using either handles or extensions to facilitate gaging.



Extended range air plugs - oil industry

Air tooling is available for measuring long bores, such as pump barrels used in the oil field industry. The tooling is modified to have up to a 0.254 mm / 0.010 in total range. It carries a DPS model number identifier and is basically 2500:1 tooling with extra clearance, a 1/4 in polished, trailing and leading edge radius, as well as AlChrNi coating to provide maximum wear life. The tooling is designed for use on Millimar systems calibrated for the extended range.

The plugs are typically used with a 30 ft long hose. AHO-SPEC-102 is a rubber hose and AHO-SPEC-175 is a heavy duty hydraulic hose. The system is ideal for accurately measuring size within ± 0.005 in of zero, but also when extended range is needed for approach and over or for monitoring bore wear typical for pump barrels.

Ranges available for pump barrel tooling:

- 5-0-5: ± 0.127 mm / ± 0.005 in
- 8-0-2: $+0.200$ mm / 0 / -0.050 mm
 $+0.008$ in / 0 / -0.002 in
- 9-0-1: $+0.225$ mm / 0 / -0.025 mm
 $+0.009$ in / 0 / -0.001 in



To achieve this longer range with the C 1202 or Cockpit system, the N 1701 PE-F is adapted to the longer range tooling. When ordering display for the extended range tooling, order 2261779 N 1701 PE-F and specify the range to the tooling the module will be used with.





Materials

Standard air plugs are normally furnished in high chrome content stainless steel. Mahr has extensively tested this material and it has demonstrated extremely long life and strong resistance to rusting. In fact, the wear characteristics are so good that no additional coating is required.

Air tooling can be used for extremely high volumes of parts and dynamic applications either manually or in automated stations where wear can impact the life of the tooling. For these applications, and in order to help eliminate environmentally hazardous processes, Mahr is employing an AlCrN-based coating, on its tooling. With this coating we are able to significantly improve the life performance of air tooling. This results extremely wear resistant coating also provides with excellent hardness and resistance to shocks. In short, this coating provides superb results in high wear and high humidity applications. This material also provides a dark, rich look to the plug. As such should and when wear does effect the plug the lighter under coated material will begin to show through signifying that the plug should be inspected for wear.



Special jet locations

For certain applications such as blind holes, measuring lands along a bore or simply measuring a diameter. Special jet locations can be called out as part of the plug requirements. If the jets are to be located at a distance from the bore opening, a shoulder can be machined into the plug or stop collar used as a jet positioning reference.



Multiple bore diameters

No other measuring technology can provide sensors, as in the case with air tooling, the jets so close together and at multiple locations along a bore or multiple bore diameters.

Part requirements may call for multiple diameters (the same or different) to be measured simultaneously. Special plugs having multiple jets at different diameter positions can speed up the gaging process by measuring all features at once with Millimar multi-channel gaging.



Special jetting for short lands

Often on small high precision parts such as hydraulic valves or planetary gears bore diameters may not be long enough for the standard orifice size of the Mahr jet used in a typical plug. In these cases our experienced design team can provide a number of unique solutions to measure these short lands. Solutions may include using smaller diameter jets, employing three smaller jets or designing small rectangular or oblong jets into the plug. A shoulder or stop collar used on the plug would further ensure proper diameter location.

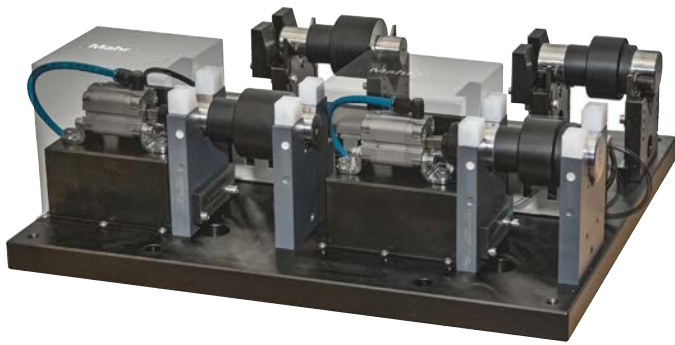

Automated gaging

Air gaging can be successfully used as part of an automated process. Designs can be made to account for these applications. To help in part alignment the leading edge of the air plug is critical for either making entry into the part easy or aligning the part to the bore thus an easy entry lead in can be incorporated. Also, Mahr Federal has an extensive library of compliance fixtures to help guide the plug into the part when staging is not properly aligned to the part.

We also can provide gaging stations that can be implemented into robot loaded work stations that allow for easy part loading and direct feedback to the station controller.



Air tooling for larger sizes

Typically air gaging is thought of a solution for high volume parts because of its ease of use and ability to measure parts quickly with high precision. However, there are application on large parts where critical bores need to be measured at the point of manufacture.

Air gaging may be the choice for these applications also. These large parts cost many thousands of dollars to produce. While still in the machining center air gaging may be the only choice for achieving that accuracy needed to measure the critical dimensions. Special large air plugs, rings or snap gages can be produced for this critical in process dimension.

As part of the design for these large dimensions special consideration can be given to making the gage as easy to use as possible by employing weight lightening holes or making hoop style rings or plugs to further reduce weight. But as will all Mahr air tooling standard performance specifications are maintained for these larger sizes.



Special shapes

Air tooling for precision bores is by far the most common air gaging application. However, air tooling can be configured to meet virtually any gaging requirement. These may include:

- Square or rectangular plugs for measuring width
- Plugs for measuring partial chords in a ball socket
- Spherical shaped plug gages to check partial spheres or bores
- Taper air plugs for round, oblong or 3-lobe tapers
- Plugs measuring multiple diameters in pump housing
- "Mouse gages" designed to measure and explore slot widths in parts
- 5-circuit air plugs/ring for min/max diameters on stators



Stop collars / slit jets

For precisely positioning the plug at specified depths, a stop collar is the effective solution. These inexpensive options are a must for short bores. They position the measuring jets at the proper location while assuring the plug is square to the bore.

For short lands, standard jetting may be replaced with alternate jet configurations. When combined with a stop collar, these short lands can be inspected.



Air gaging to measure small diameter through holes

When the gage requirement is to measure hole diameters smaller than 1.5 mm / 0.060 in air gaging offers unique options. For applications such as this the small orifice itself becomes the restrictor and back pressure or flow can be used to check hole size. Flow based on a controlled system makes it possible to monitor the maximum diametrical size of a hole or orifice. Flow rate is typically classified by two points in a fixed range and allows air gage systems to use a min and max master to verify pass or fail part status very simply. Systems can range from a single column gage for a dedicated orifice size or full PC system that cover a range of sizes. Diameters from 0.1 mm / 0.004 in to 1.5 mm / 0.060 in are achieved with flow rates from 0.2 to 20 lpm (liters per minute). Repeat better than 1 μ m / 40 μ in and linearity better than 2.5 μ m / 100 μ in are possible.



Applications suitable for this type of system are small nozzles, valve components, needles, restrictor of most any type of material, plastic, metal, or other. These systems are commonly used for high volume product or where mechanical and optical solutions are unable to meet the requirement. Air gages are fast, reliable, and easy to use and a suitable choice for flow measurement.



Air gaging for electric motors

Many measuring tasks are carried out with measuring hand tools such as calipers and micrometers. However for the critical diameters such as those found on the bearing diameters in the end housing or the critical motor shaft diameters, air gaging is the choice at the point of manufacture.

Often odd number lobing is found with the bearing diameter bores on the motor housing because of the manufacturing process used to create the holes. For this a 3-jet blind hole air plug is ideal since it provides high resolution results of this precision bore, based on the bores form.

When the electric motor shaft is being turned or ground in the machine an air snap is the fastest and easiest-to-use precision gage to measure the diameters. Data can be collected and even fed back to the machine for automatic size control. A wide range of display options provide clear feedback to the operator.



Shown with 2252413 data send handle



Air gaging stations for engine blocks

An air gage station provided to measure all the critical bores in a small engine block. The station includes a gaging computer, the various air tooling, and masters in an enclosed work station. The crank and cam bores are measured with 2-jet air plugs having long handles that allow orientation of the air jets and an indication of the journal locations. The balance shaft bore, due to its broad tolerance and high surface finish, is checked with a special mechanical plug assembly. Finally the cylinder bores are measured with a multiple jet plug having four planes. Each plane has four jets for two diameters set at 90° apart.

The gaging computer displays the measured results for each feature. The operator is guided through a prescribes gaging sequence. The gaging computer has an integrated SPC package, data storage and user programmable output for interfacing to machine tool feedback



Air gaging for orthopedic applications

In one case a manufacturer of orthopedic implants needed to improve measurement and documentation proficiency of parts with literally hundreds of configurations. Air gaging was desired because it can quickly and accurately measure precision tapers. But because air gaging is custom made for the application, there can be just as many air tools as there are part variations – a logistics nightmare when there are thousands of component combinations.

To reduce the number of tools, Mahr designed a unique master air tool with multiple jetting and a series of spacers that allowed one tool to be used on all the various tapers, regardless of length. The gage could be zeroed on a single master spacer and the operator could measure parts by selecting the appropriate spacer.

Air gaging is the ideal solution for measuring precision orthopedic taper parts. Since the air jet sets are so small and can be placed into close proximity in small tooling, measuring the tapers for diameter and taper is fast and easy.

Whether it be for stems, cups or balls the tooling can be used at the point of manufacture to ensure the process is manufacturing the tapers to the critical dimensions.



Air tooling for gun barrels and chambers

Air gaging offers many advantages when it is required to ensure the quality of gun bores (with rifling or straight bores) or the characteristics of the shell chamber. The small size of the jets and ability to combine multiple circuits into an air tool. Air plugs can be designed to measure the lands and groove on bores as small as 6 mm and all sizes to 150 mm larger over the full range of the bore.

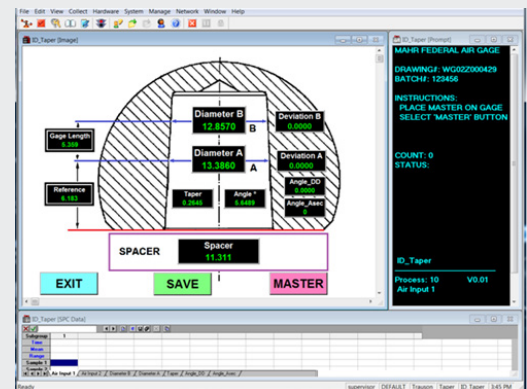

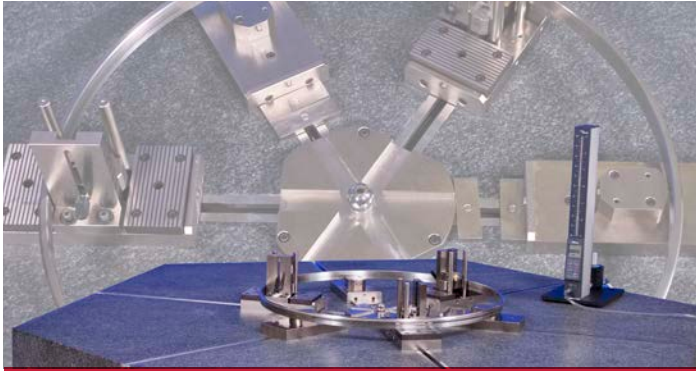

Masterless ID/OD gage for large diameters

Today's precision thin section bearings offer high running accuracy in a low profile design to meet specific application requirements. Basic components of a large diameter gage for thin walled parts start with a ridged plate which varies in size based on the part sizes to be measured up to 80 inches. On the plate are 6 radial grooves in which the sensing heads run along. A precision ball and gage blocks make this a masterless gaging system.

Because of the 6 measuring points a multi-function display can be used to display numerous diameters including:

- Three two point diameter
- Two three point diameters
- The average of the two and three point diameters
- 2, 3 or 6 point out of round

The part can even be rotated 60 degrees to have another complete set of diameters for the part



Air gaging station for total part measurement

The Mahr PC air gage system is designed to measure various internal (ID) and external (OD) diameters on a transmission housing. A series of air tools are connected with size specific to the feature and part type to be measured. Measurements are performed manually and in a specific sequence. Each tool resides in its nominal master during operation. The system is laid out on a workbench with the part measured at the center of the bench. A PC w/17" integral touchscreen monitor rests on top of the control cabinet for elevated viewing. Data may be manually or auto collected depending on setting. Mastering is performed automatically requiring all tooling to be stored in its nominal master during the measurement routine. Data is logged to a text file for backup as needed. A reader/scanner (customer provided) may be used for gathering information to be displayed and logged with the measurement data.



Machine tool spindles and taper tool holders

With a taper jet air plug or air jet ring with three indicating columns and 2 air /electric converters inputs the following parameters can be evaluated:

- Large diameter
- Small diameter
- Taper D1-D2
- Taper ratio $L/(D2-D1)$
- Nominal diameters at a defined height $D1+((D2-D1)*L1/L)$

Or with the use of a gaging computer multiple diameters can be combined for complete tool holder and spindle analysis

As the demands for precision machining and high speeds increase, manufacturing tolerances on spindle and tool holder tapers have gotten tighter. Air taper gages are designed to match the parts taper and measure multiple diameters along the length of the taper. Then by comparing the diameters the taper and its shape can be measured. Mastering is simply a matter of inserting the taper master and adjusting the zero. Measuring is even easier: just insert the part and take the reading.





Multiple diameters

Stators and Rotors found in motors have tolerances both on the large and small diameter. Because the air jet is so small and can be built into complex shaped tooling, air gaging provides the capability of having multiple jets placed in very close proximity to each other. There are very few sensors that have this characteristic.

In this application special part-like tooling was created that is capable of measuring two diameters simultaneously on the odd numbered (5) interrupted surfaces. And the part diameters are measured at three levels which requires 30 air jets per tool. The system is completed with two sets of three air columns displays so that all size diameters are displayed separately and can easily be scanned for both size and form errors such as taper or barrel shape.



Turnkey workstations jet engines

The Mahr rotor gaging system utilizes air gaging and wireless indicator technology to measure various features on a compressor rotor. Gage components are staged on a roller cart for portable use.

Features measured are:

- An ID (Inside diameter using an air plug)
- Several OD's (Outside diameter using air snaps)
- Some length/distance gages (using integral wireless indicators).

The air tooling uses quick connect fittings which allows easy switching from one size to the next. The handle used for the air tooling incorporates a pushbutton switch used for data collection. All gaging components are mounted to a robust mobile cart for easy transportation to the point of manufacture.

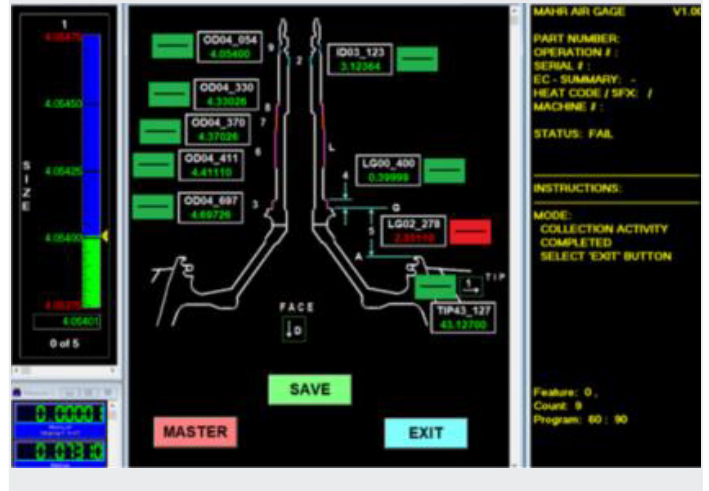

Quality dimensional measuring instruments services

International Standards require complete documentation and calibration of all gaging instruments. Mahr Inc., as well as being a manufacturer of quality dimensional measuring instruments, is an established primary source for high accuracy dimensional measurement services.

Mahr offers an inspection and recalibration program for dimensional standards including:

- Gage blocks
- Master rings
- Master discs and plugs
- Master balls (roundness)
- Cylindrical form and precision reference specimens surface roughness standards.

For these services, we have created an ideal environment - a metrology laboratory in Providence, Rhode Island that is ranked as one of the world's finest:

- High quality measurements - 0.06 micron / 2.3 micro inch uncertainty of measurement on gage blocks (up to 50 mm / 2 in long).
- All measurements traceable to the Standards of the United States.
- Grand Masters/Primary standards used in our Measurement Center have been certified by NIST.
- Calibration system is certified to ISO-9001:2008 by NQA, USA and accredited to ISO 17025 NVLAP Lab Code 200605-0.
- We offer fast turnaround and competitive prices.

Mahr also specializes in the calibration and certification of the following gages including:

- Dial, digital and test Indicators
- Mikrokators
- Micrometers
- Dial and vernier calipers
- Pin and radius gages
- Snaps, ID / OD and bore gages
- Dimentron plugs
- Plug and ring gages
- Groove, caliper, thickness, thread, height and depth gages
- Air gages and magnification kits
- Electronic amplifiers and gage heads
- Surface finish gages
- Level systems



Certificate of Registration



This is to certify that the Quality Management System of:

Mahr Inc. (HQ)
 1139 Eddy Street
 Providence RI 02905
 United States of America

(Central function listed above. See appendix for additional locations) applicable to:

Sales, design, manufacture and servicing of dimensional gages and gaging systems, optical instrumentation and optical measuring systems, and dimensional calibration services including field service for masters, standards and gages

has been assessed and approved by National Quality Assurance, U.S.A., against the provisions of:

ISO 9001:2015

For and on behalf of NQA, USA

Certificate Number: 10057
 EAC Code: 19_34
 Certified Since: October 6, 1995
 Valid Until: August 21, 2025
 Reissued: August 22, 2022
 Cycle issued: August 22, 2022



MANAGEMENT SYSTEMS CERTIFICATION BODY

Page 1 of 2

This approval is subject to the company maintaining its system to the required standard, which will be monitored by NQA, USA, 289 Great Road, Suite 105, Acton, MA 01720, an accredited organization under the ANSI National Accreditation Board.

52 | Air gaging

Worksheet for ordering air plugs

There are two basic styles of air plugs, through hole and blind hole Styles. Dimension “B” refers to the dimension of the jet centerline to the nose of the air plug. The overall dimension is indicated by Dimension “A”. There is an option for super blind plugs that further reduces Dimension “B”, permitting checking closer to the bottom of the part. If extra length is necessary and an extension or handle will not work, you can specify extra plug length in 25 mm / 1 in increments. NON-Relieved should only be specified for valve bores where obstructions like lands could make it difficult to remove the tool.

When possible specify the Dimensionair model number you are ordering the tooling for.

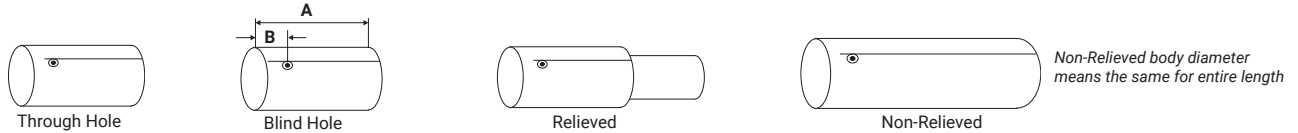

Required Information		Options for Air Plugs	
Feature Size (Bore Diameter)		Stop Collar	
Size Tolerance		OD Restrictions	
Number of Jets*		Special Plug Markings	
Plug Style: Through, Blind		Extensions / Length	
Location Jets		ISO Long Form Certification of Air Plug	
Extra Body Length		Tooling	
Extra Length*		Handle	
Quantity		Shut-off	
Overall Bore Length*		Master	
Dimensionair Display (to be used)		Nominal	
Part Prints (for other than non-standard plugs)		AMR Calibration Kit	
Surface Finish		AFL-24 Oil/Water Trap	

* 2 jet check size, ovality, taper, bellmouth; 3 jet check 3 point out of round; 4 jet Average diameter, requires special Dimensionair; 6 jet Average 2 point and 3 point out of round, requires special Dimensionair.

Worksheet for ordering air rings

Special care MUST be taken when preparing proposals for air rings. There are five basic styles of air rings centered jets, offset jets, shoulder type, counter bored type, and snout type. Air rings may be attached directly to the Dimensionair, or used with base and guide chutes that can only be provided at time of manufacture. Mahr strongly recommends a drawing (CAD preferred) accompany this inquiry.

Required Information		Options for Air Rings	
Feature Size (mm/in)		OD Restrictions	
Size Tolerance		Special Plug Markings	
Number of Jets*		Base	
Air Ring Style: <ul style="list-style-type: none"> • Center jets • Offset jets • Shoulder style • Counter bored • Snout 		Guide Chutes: <ul style="list-style-type: none"> • Vee style • Tube Style • Length 63 mm / 2.5 in or 152 mm / 6 in 	
Quantity		ISO Long Form Certification of Air Ring	
Overall Length of Diameter		Tooling Hose	
Dimensionair Display (to be used)		Shut-off	
Part Prints (for other than non-standard plugs)		Master	
		Nominal	
		AMR Calibration Kit	
		AFL-24 Oil / Water Trap	

* 2 jet check size, ovality, taper, bellmouth; 3 jet check 3 point out of round; 4 jet Average diameter, requires special Dimensionair; 6 jet Average 2 point and 3 point out of round, requires special Dimensionair.

Worksheet for ordering parts

Ordering Master Rings

Requirement: (1) Nominal sized master or, (optionally) (1) Minimum and (1) Maximum Deviation Master

Single (zeroing) Master Information			
Measurement Units	<input type="checkbox"/> Inch <input type="checkbox"/> Metric	Quantity	<input type="checkbox"/> 1 <input type="checkbox"/> 2 <input type="checkbox"/> 3 <input type="checkbox"/> Other
Nominal Master Size		Class	<input type="checkbox"/> Y <input type="checkbox"/> X <input type="checkbox"/> XX <input type="checkbox"/> XXX
Material	<input type="checkbox"/> Steel <input type="checkbox"/> Chrome	Special Marking	
Certification to Class	<input type="checkbox"/> Yes <input type="checkbox"/> No	Certification to Size <i>(extra cost)</i>	<input type="checkbox"/> Yes <input type="checkbox"/> No
Tolerance Applied	<input type="checkbox"/> Bi-Lateral (per rules for nominal masters) <input type="checkbox"/> Uni-Lateral (Per rules for Go / NoGo masters)		
Deviation Master Information			
Measurement Units	<input type="checkbox"/> Inch <input type="checkbox"/> Metric	Quantity	<input type="checkbox"/> 1 <input type="checkbox"/> 2 <input type="checkbox"/> 3 <input type="checkbox"/> Other
Minimum Master Size		Maximum Master Size	
Material	<input type="checkbox"/> Steel <input type="checkbox"/> Chrome	Special Marking	
Certification to Class	<input type="checkbox"/> Yes <input type="checkbox"/> No	Certification to Size <i>(extra cost)</i>	<input type="checkbox"/> Yes <input type="checkbox"/> No
Class	<input type="checkbox"/> Y <input type="checkbox"/> X <input type="checkbox"/> XX <input type="checkbox"/> XXX		
Tolerance Applied	<input type="checkbox"/> Bi-Lateral (per rules for nominal masters) <input type="checkbox"/> Uni-Lateral (Per rules for Go / NoGo masters)		

Ordering Master Rings Plugs and Discs

Requirement: (1) Nominal sized master or, (optionally) (1) Minimum and (1) Maximum Deviation Master

Single (zeroing) Master Information			
Measurement Units	<input type="checkbox"/> Inch <input type="checkbox"/> Metric	Quantity <i>is Required</i>	<input type="checkbox"/> 1 <input type="checkbox"/> 2 <input type="checkbox"/> 3 <input type="checkbox"/> Other
Nominal Master Size		Class	<input type="checkbox"/> Y <input type="checkbox"/> X <input type="checkbox"/> XX
Material	<input type="checkbox"/> Steel <input type="checkbox"/> Chrome	Special Marking	
Certification to Class	<input type="checkbox"/> Yes <input type="checkbox"/> No	Certification to Size <i>(extra cost)</i>	<input type="checkbox"/> Yes <input type="checkbox"/> No
Tolerance Applied	<input type="checkbox"/> Bi-Lateral (per rules for nominal masters) <input type="checkbox"/> Uni-Lateral (Per rules for Go / NoGo masters)		
Style	<input type="checkbox"/> Disc <input type="checkbox"/> Plug		
Deviation Master Information			
Measurement Units	<input type="checkbox"/> Inch <input type="checkbox"/> Metric	Quantity <i>is Required</i>	<input type="checkbox"/> 1 <input type="checkbox"/> 2 <input type="checkbox"/> 3 <input type="checkbox"/> Other
Minimum Master Size		Maximum Master Size	
Material	<input type="checkbox"/> Steel <input type="checkbox"/> Chrome	Special Marking	
Certification to Class	<input type="checkbox"/> Yes <input type="checkbox"/> No	Certification to Size <i>(extra cost)</i>	<input type="checkbox"/> Yes <input type="checkbox"/> No
Class	<input type="checkbox"/> Y <input type="checkbox"/> X <input type="checkbox"/> XX <input type="checkbox"/> XXX		
Tolerance Applied	<input type="checkbox"/> Bi-Lateral (per rules for nominal masters) <input type="checkbox"/> Uni-Lateral (Per rules for Go / NoGo masters)		
Style	<input type="checkbox"/> Disc <input type="checkbox"/> Plug		

Note: Mahr recommends XX masters certified to size instead of XXX certified to class.



Mahr Inc.
1139 Eddy Street
Providence, RI 02905

+1-1800-343-2050
www.mahr.com

